



SPECIFICATION SHEET

5G NR MIMO x 4 ANTENNA

MESSERS.	
DESCRIPTION	5G ANTENNA
PART No.	FES-7F0ENR4

ACCEPTANCE		
PREPARED	CHECKED	APPROVED
/	/	/

SUPPLIER		
PREPARED	CHECKED	APPROVED
		
09/05	09/05	09/05

◆ INDEX

— INDEX	----- 2
— REVISION HISTORY	----- 2
— APPLICATIONS	----- 3
— ELECTRICAL SPECIFICATION	----- 3
— MECHANICAL & ENVIRONMENTAL SPECIFICATION	----- 3
— ANTENNA DIMENSION	----- 4
— RADIATION PATTERN	----- 5-10

◆ REVISION HISTORY

NO	DATE	REVISION	NOTE	AUTHORS
1	2024.09.05	00	First Draft	LEE.

◆ APPLICATIONS

- MOBILE STATION, BASE STATION SYSTEM
- VOICE CALLS SHORT MESSAGES
- SMART GRID AUTOMATION, REMOTE SURVEILLANCE
- SMART TRAFFIC MANAGEMENT, SMART METERS
- VEHICLE TRACKING ENERGY SYSTEM, MOBILE TV etc. OTHERS

◆ ELECTRICAL SPECIFICATION

ITEM		SPECIFICATIONS
Antenna	Frequency Range	698~960MHz/1710~2690MHz/2900~3800MHz /4400~5000MHz
	Polarization	Linear
	Gain	4dBi (Typ.)
	V.S.W.R	≤3.0 min
	Impedance	50Ω

◆ MECHANICAL AND ENVIRONMENTAL SPECIFICATION

ITEM	SPECIFICATIONS
Cable	LMR100*4
Connector	SMA or others
Mounting Method	Screw
Dimensions	182x189x(85+22.7)±4mm
Operating Temperature	-40°C~+85°C
Vibration	10 to 55Hz with 1.5mm amplitude 2hours
Environmentally Friendly	ROHS Compliant

◆ **ANTENNA DIMENSION**

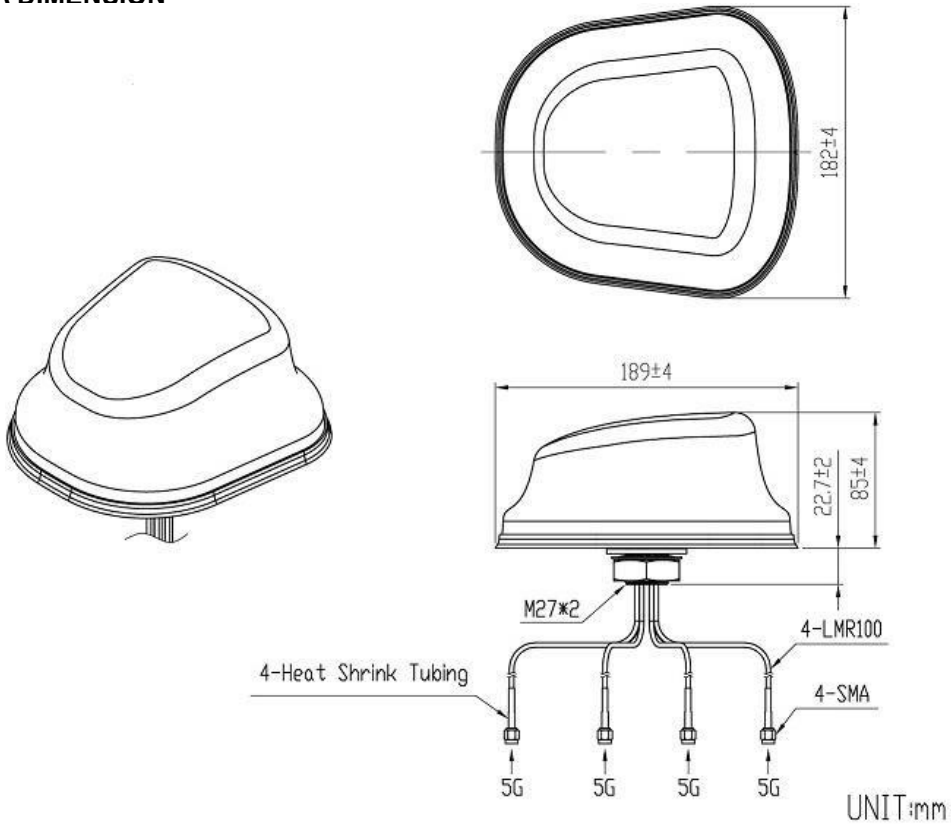

➤ **Customizable Cable and Connector**

● **Antenna Image**



◆ RADIATION PATTERN

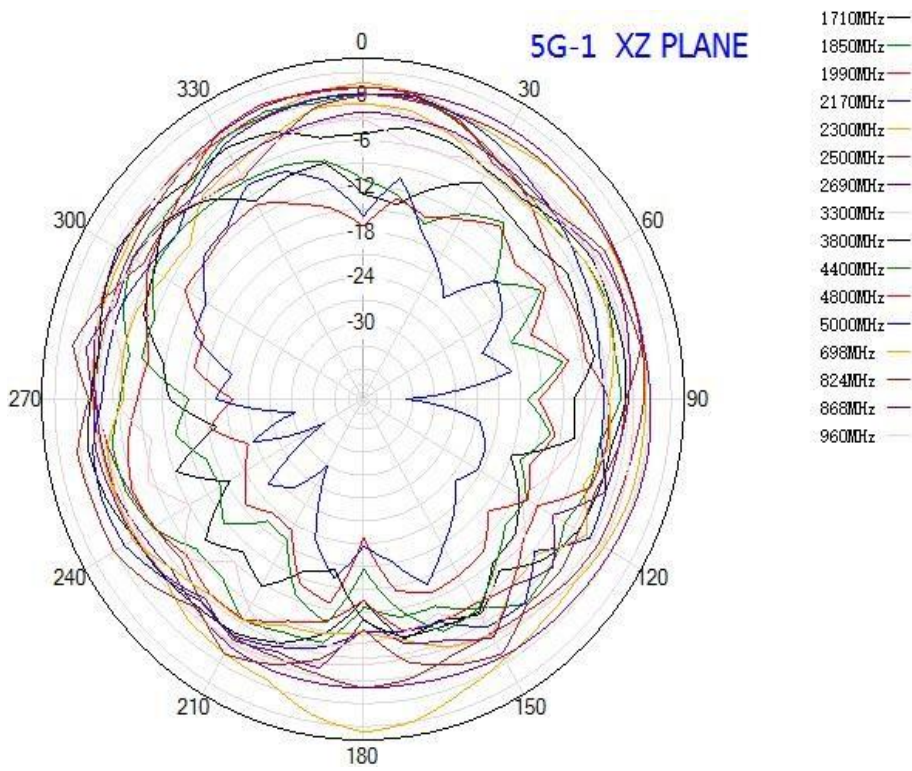
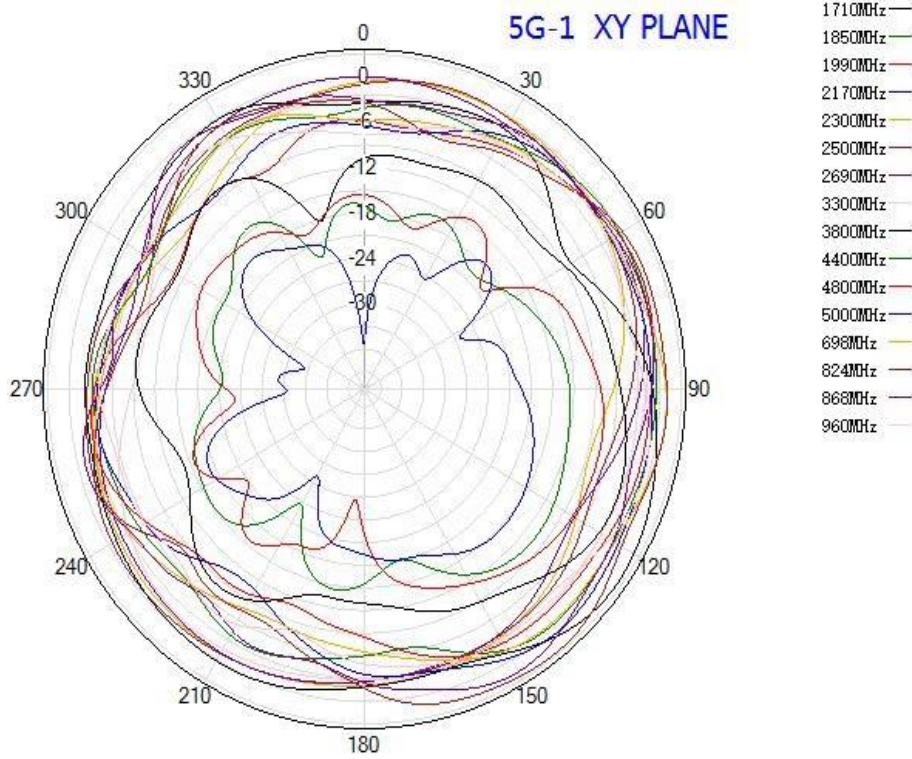

◆ RADIATION PATTERN

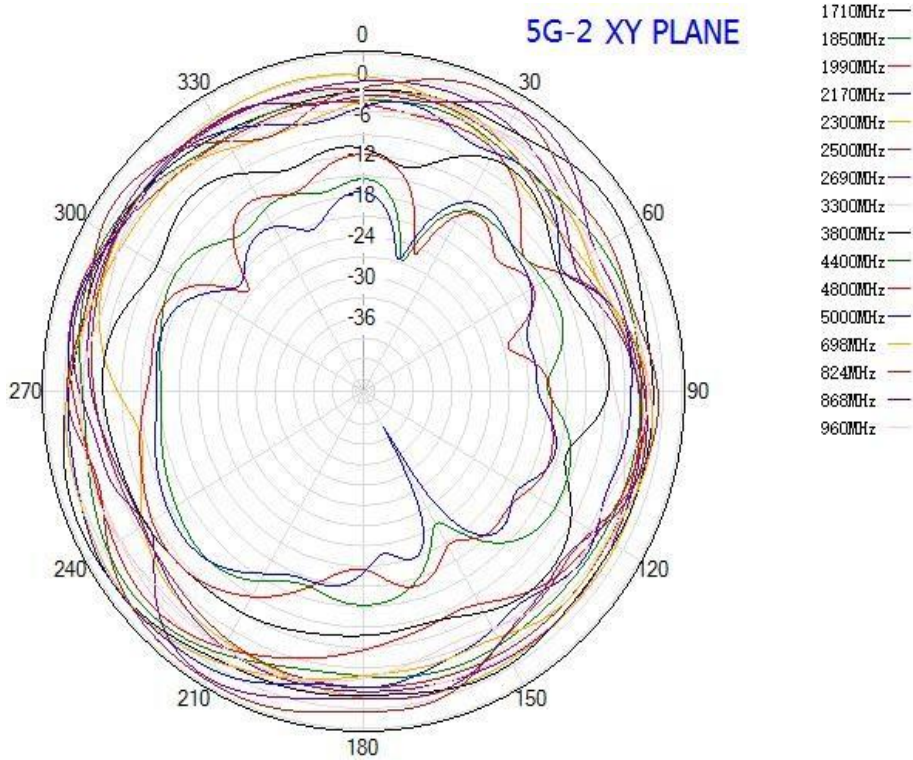
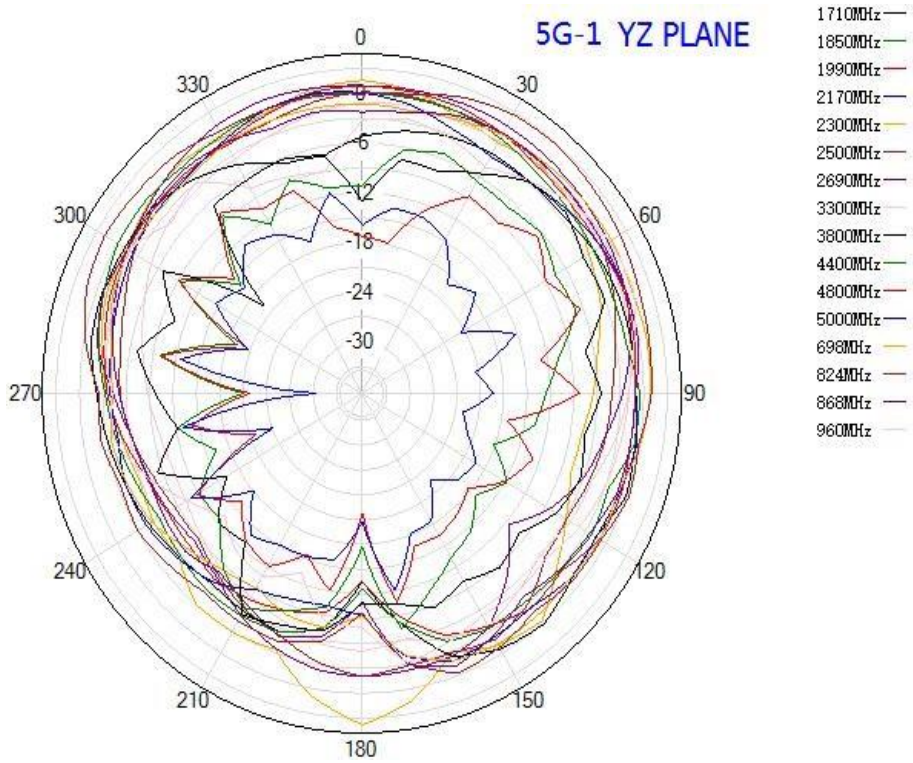

◆ RADIATION PATTERN

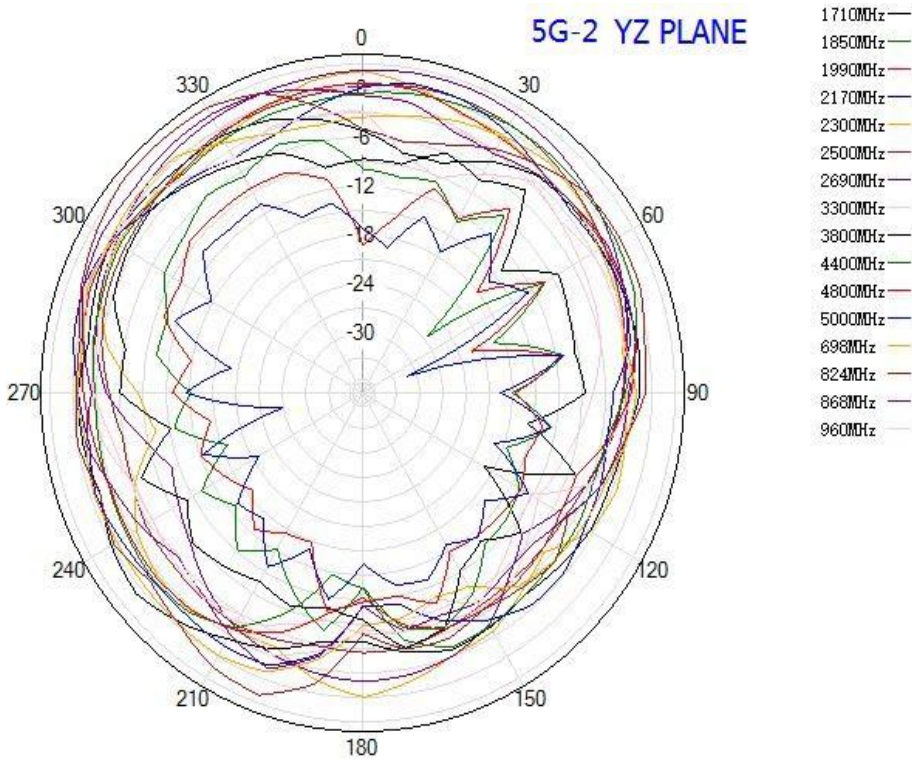
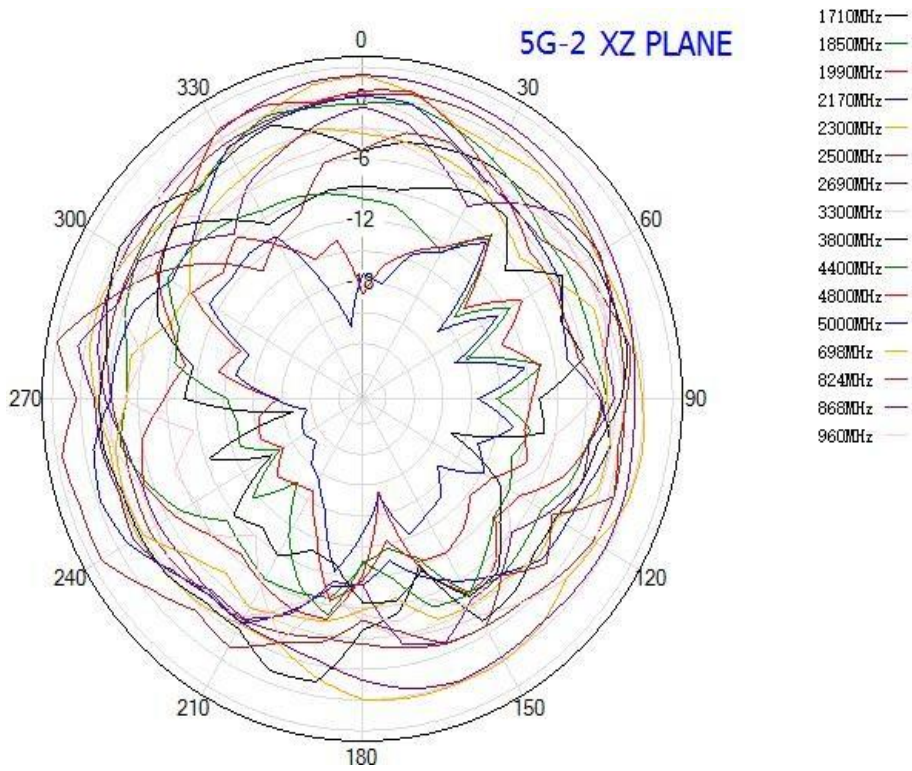

◆ RADIATION PATTERN

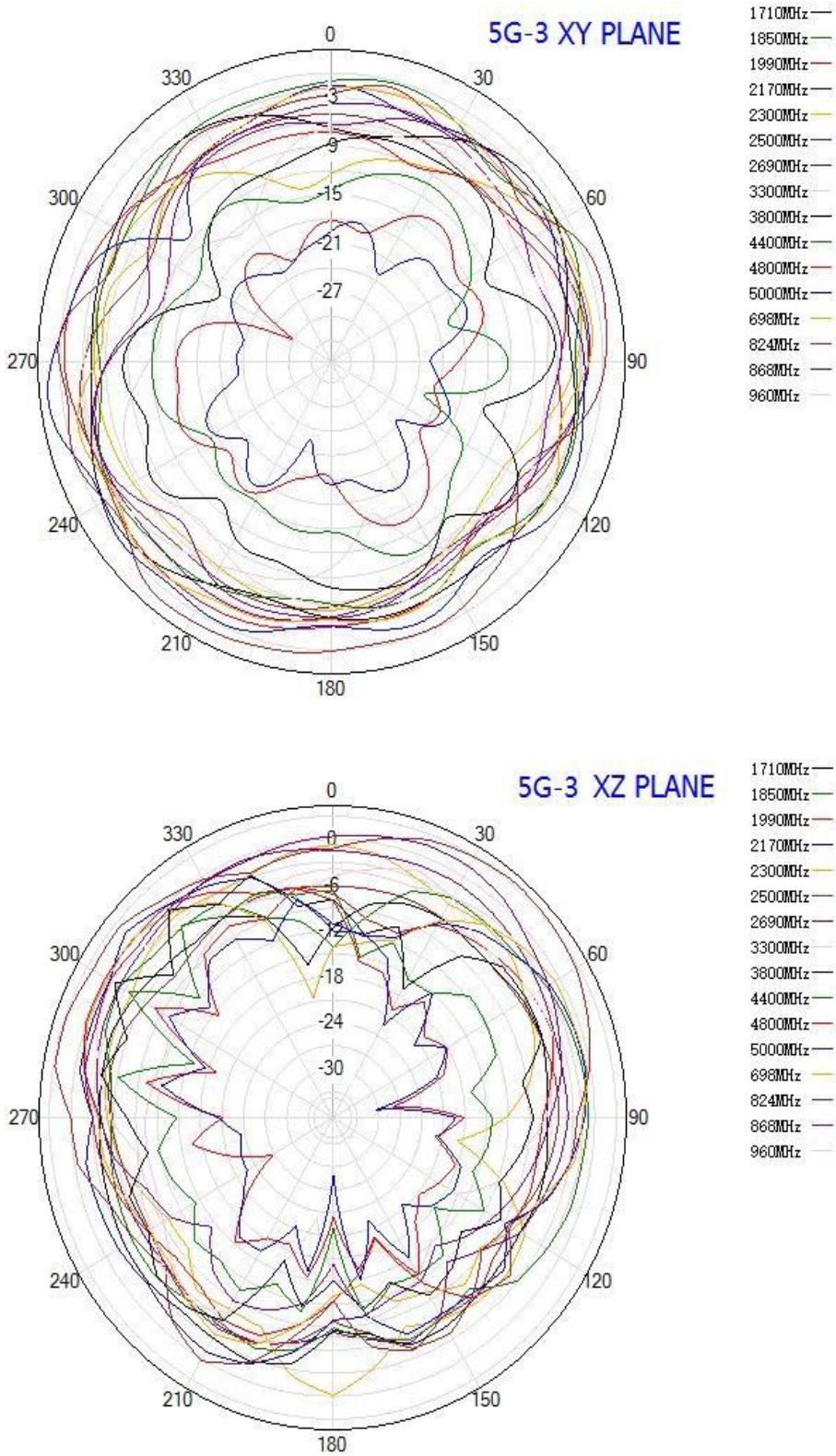

◆ RADIATION PATTERN

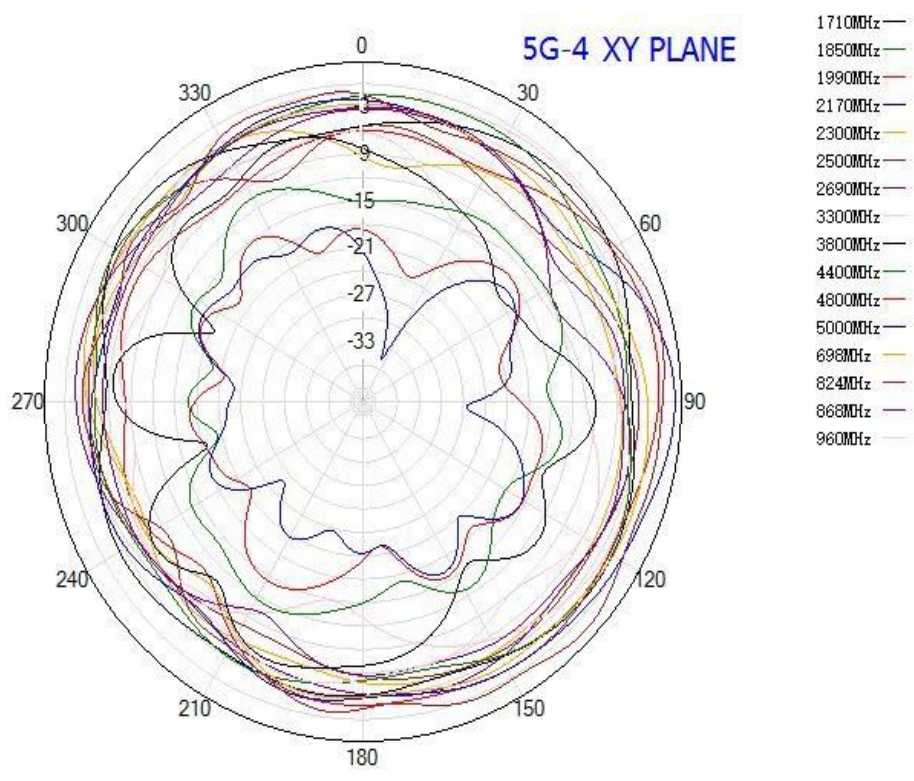
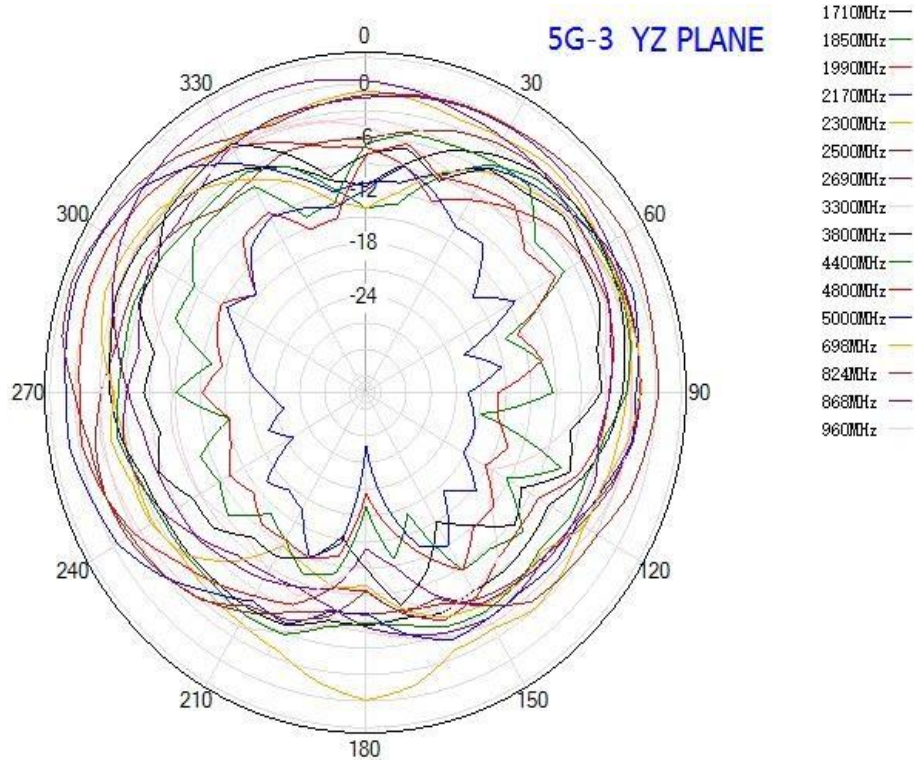

◆ RADIATION PATTERN

