



SPECIFICATION SHEET

CELLULAR ANTENNA

MESSERS.	
DESCRIPTION	GSM/3G ANTENNA
PART No.	FES-7ABF

ACCEPTANCE		
PREPARED	CHECKED	APPROVED
/	/	/

SUPPLIER		
PREPARED	CHECKED	APPROVED
		
09/05	09/05	09/05

◆ INDEX

— INDEX	-----	2
— REVISION HISTORY	-----	2
— APPLICATIONS	-----	3
— ELECTRICAL SPECIFICATION	-----	3
— MECHANICAL & ENVIRONMENTAL SPECIFICATION	-----	3
— ANTENNA DIMENSION	-----	4
— RADIATION PATTERN	-----	5-6

◆ REVISION HISTORY

NO	DATE	REVISION	NOTE	AUTHORS
1	2024.09.05	00	First Draft	LEE.

◆ APPLICATIONS

- MOBILE STATION, BASE STATION SYSTEM
- VOICE CALLS SHORT MESSAGES
- VEHICLE TRACKING ENERGY SYSTEM, MOBILE TV etc. OTHERS

◆ ELECTRICAL SPECIFICATION

ITEM		SPECIFICATIONS
Antenna	Frequency Range	824~960/1710~2170MHz
	Polarization	Linear
	Gain	0dBi
	V.S.W.R	< 2.5
	Impedance	50Ω

◆ MECHANICAL AND ENVIRONMENTAL SPECIFICATION

ITEM	SPECIFICATIONS
Cable	RF1.13/RF1.37
Connector	IPEX/MCF
Mounting Method	Adhesive
Dimensions	42.0x16.0x1.6±0.4mm
Operating Temperature	-40°C~+85°C
Vibration	10 to 55Hz with 1.5mm amplitude 2hours
Environmentally Friendly	ROHS Compliant

◆ ANTENNA DIMENSION

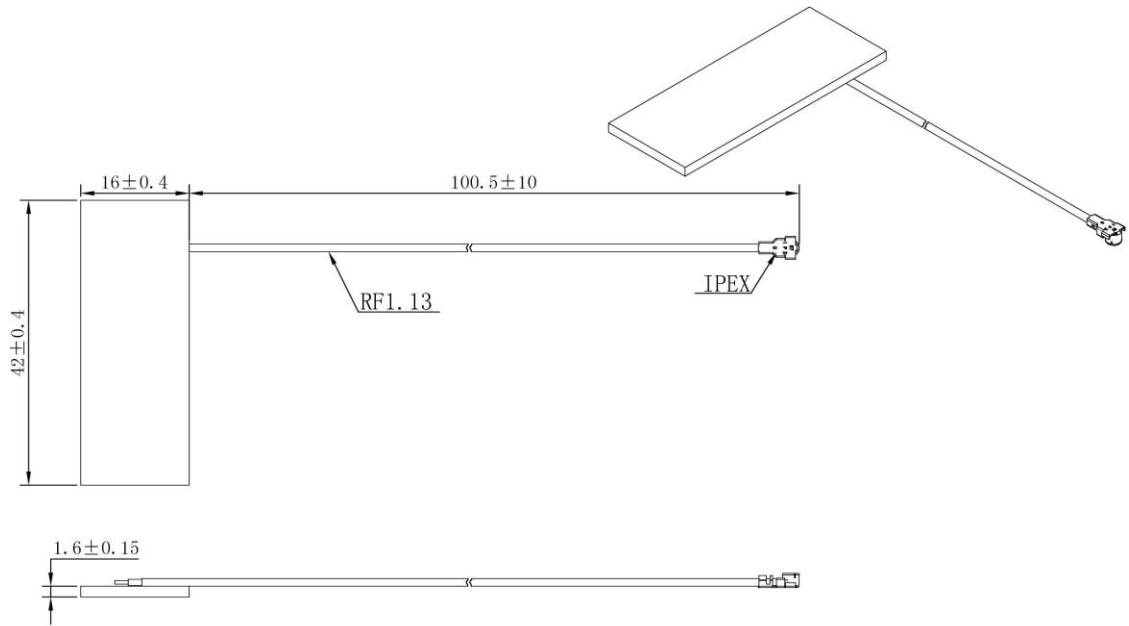

Unit:mm

➤ Customizable Cable and Connector

● ANTENNA IMAGE

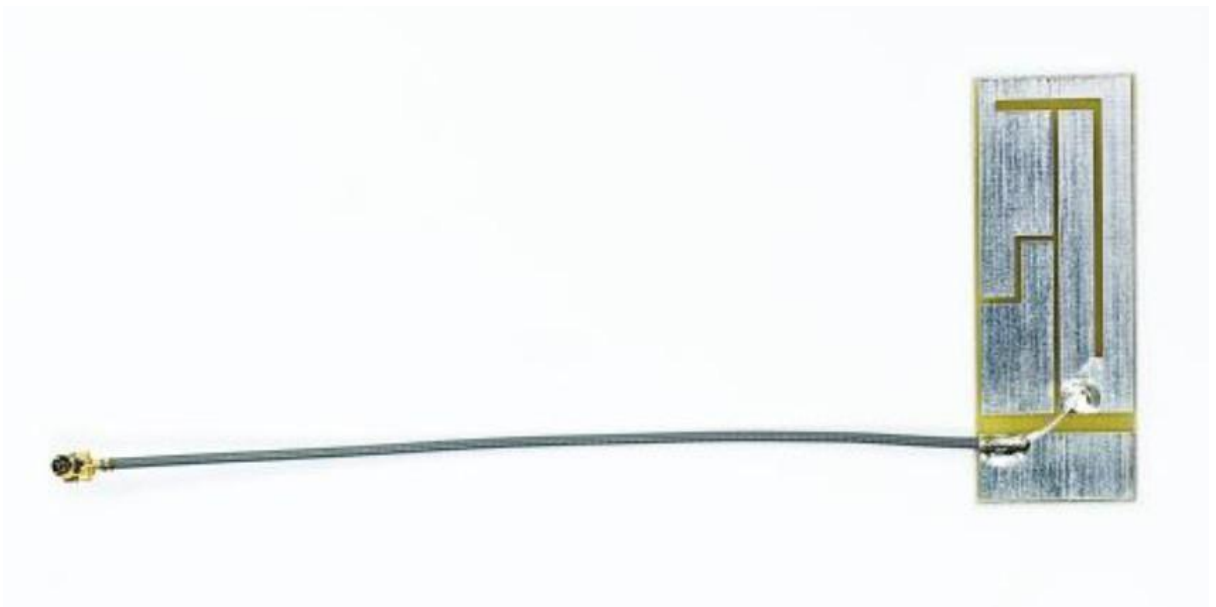

◆ RADIATION PATTERN

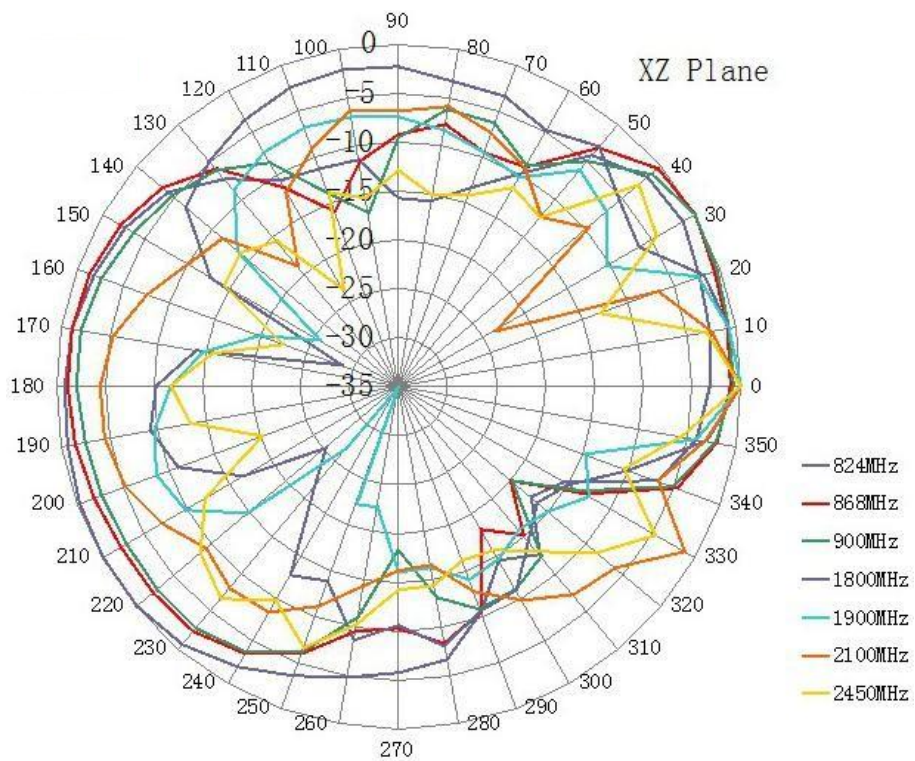
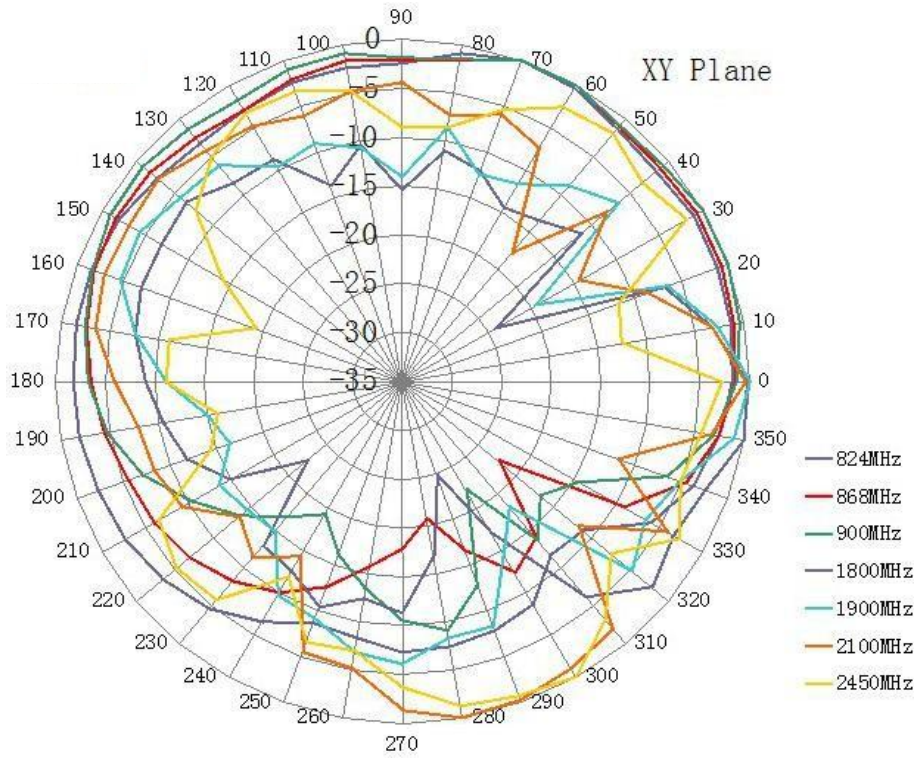

◆ RADIATION PATTERN

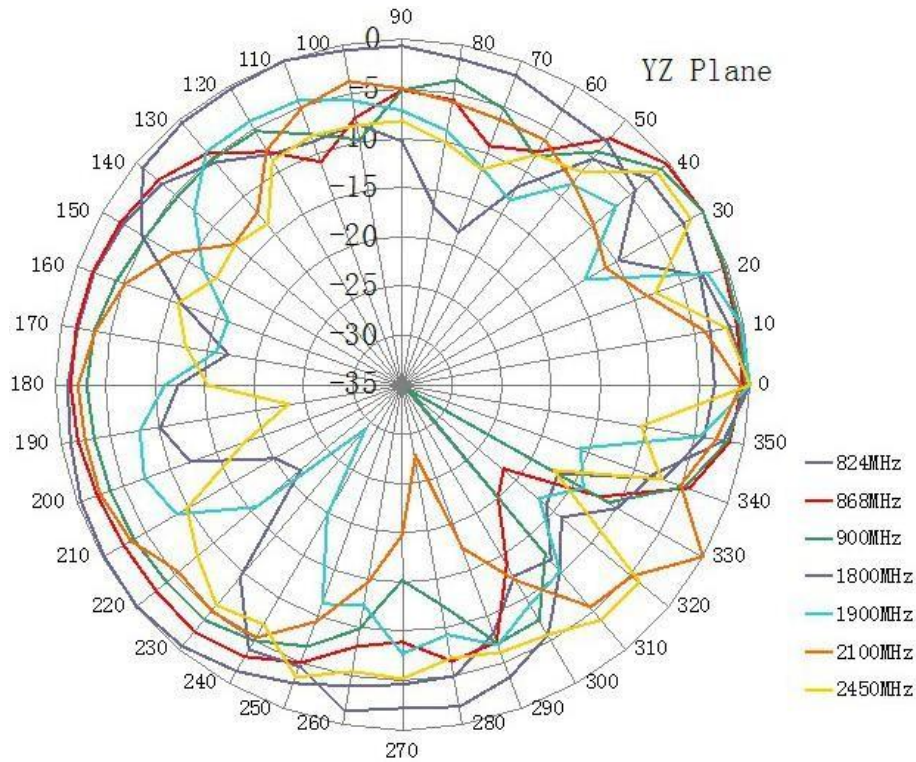

❖ 2G/3G FREQUENCY BAND

GSM/DCS/PCS/CDMA/GPRS BANDS

Bands	Frequency
GSM850	824-896MHz
GSM900	880-960MHz
DCS	1710-1880MHz
PCS	1850-1990MHz
CDMA	1920-2170MHz