



# SPECIFICATION SHEET

## CELLULAR ANTENNA

MESSERS.	
DESCRIPTION	GSM/3G ANTENNA
PART No.	FES-7ABC

ACCEPTANCE		
PREPARED	CHECKED	APPROVED
/	/	/

SUPPLIER		
PREPARED	CHECKED	APPROVED
		
09/05	09/05	09/05

◆ INDEX

— INDEX	-----	2
— REVISION HISTORY	-----	2
— APPLICATIONS	-----	3
— ELECTRICAL SPECIFICATION	-----	3
— MECHANICAL & ENVIRONMENTAL SPECIFICATION	-----	3
— ANTENNA DIMENSION	-----	4
— RADIATION PATTERN	-----	5-6

◆ REVISION HISTORY

NO	DATE	REVISION	NOTE	AUTHORS
1	2024.09.05	00	First Draft	LEE.

### ◆ APPLICATIONS

- MOBILE STATION, BASE STATION SYSTEM
- VOICE CALLS SHORT MESSAGES
- VEHICLE TRACKING ENERGY SYSTEM, MOBILE TV etc. OTHERS

### ◆ ELECTRICAL SPECIFICATION

ITEM		SPECIFICATIONS
Antenna	Frequency Range	824~960/1710~2170MHz
	Polarization	Linear
	Gain	0.5dBi (Zenith)
	V.S.W.R	<2.0
	Impedance	50Ω

### ◆ MECHANICAL AND ENVIRONMENTAL SPECIFICATION

ITEM	SPECIFICATIONS
Cable	RG178
Connector	SMA/MCX/FAKRA or others
Mounting Method	Screw
Dimensions	Ø30.5x26.0±1mm
Operating Temperature	-40°C~+85°C
Vibration	10 to 55Hz with 1.5mm amplitude 2hours
Environmentally Friendly	ROHS Compliant

### ◆ ANTENNA DIMENSION

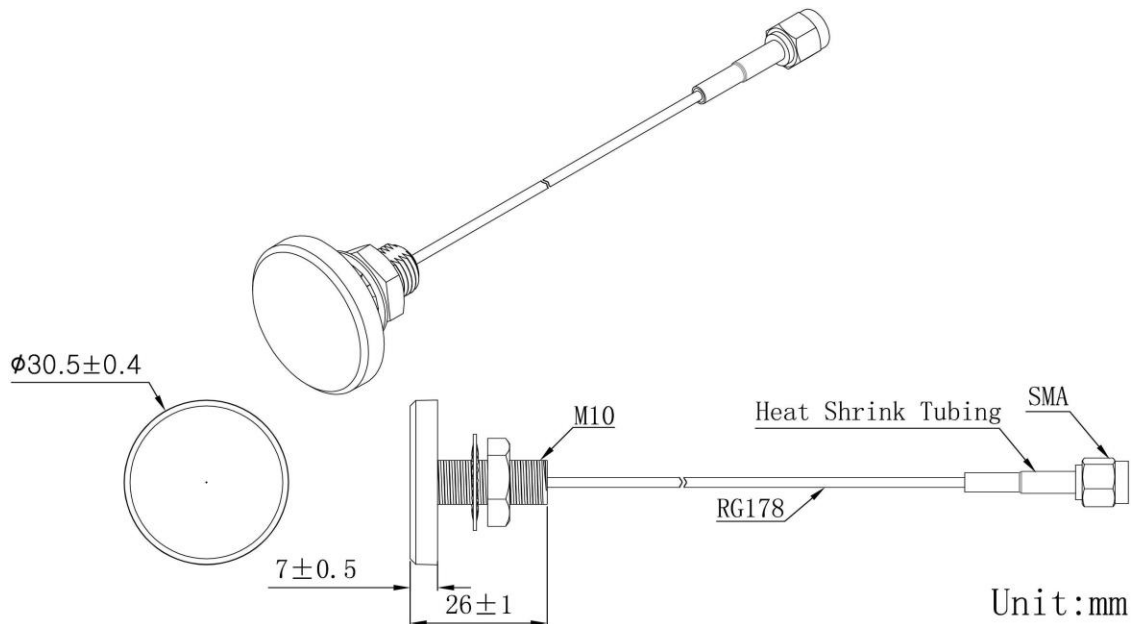

### ➤ Customizable Cable and Connector

### ● ANTENNA IMAGE



◆ RADIATION PATTERN

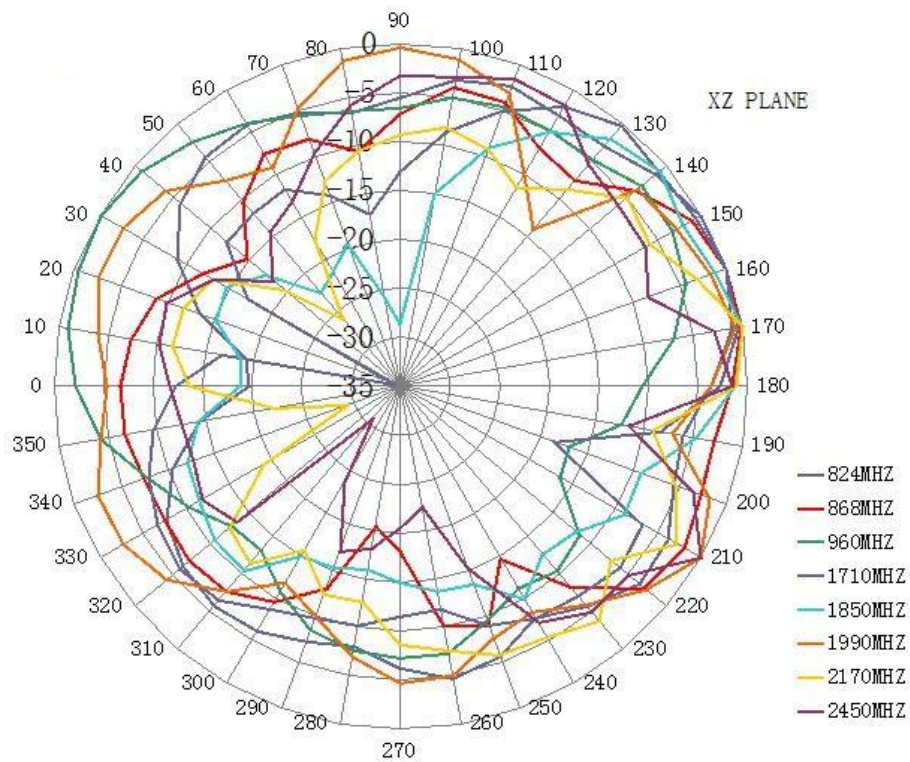
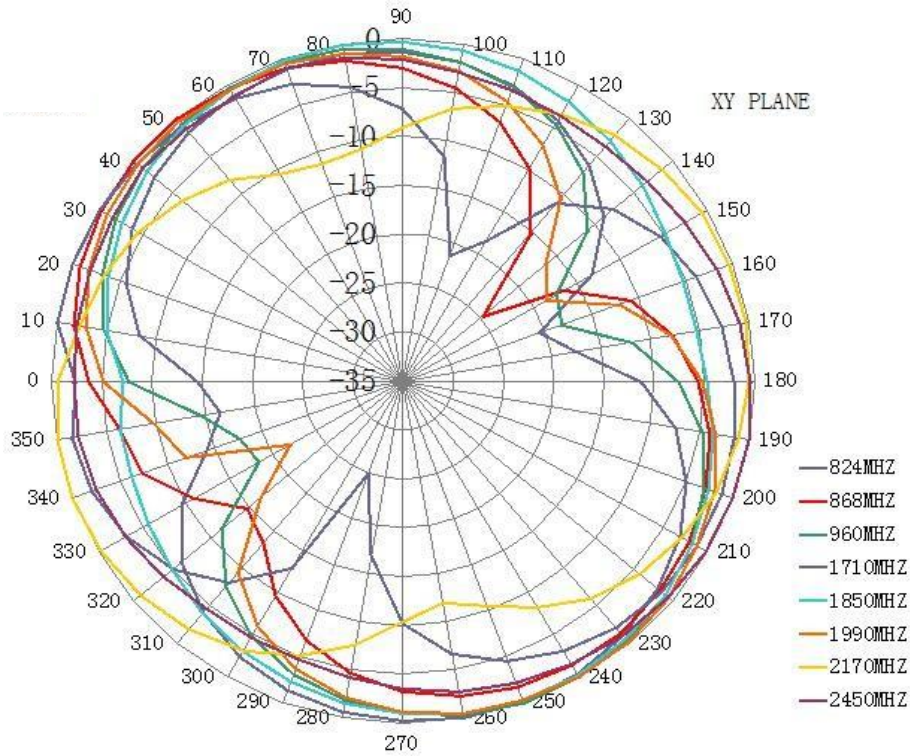

## ◆ RADIATION PATTERN

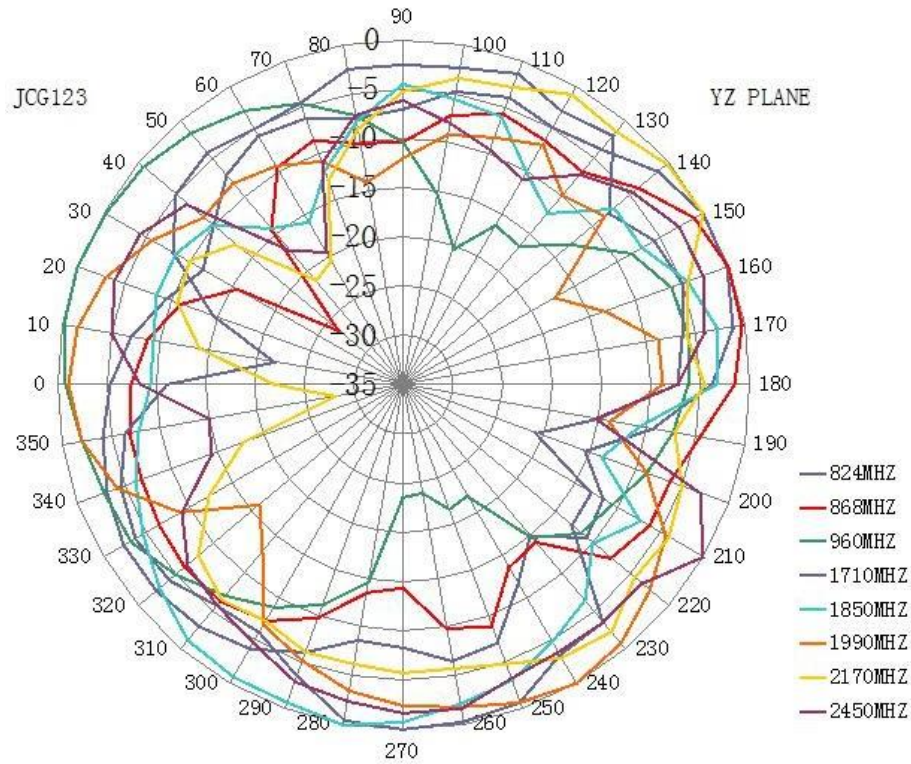

## ❖ 2G/3G FREQUENCY BAND

### GSM/DCS/PCS/CDMA/GPRS BANDS

Bands	Frequency
GSM850	824-896MHz
GSM900	880-960MHz
DCS	1710-1880MHz
PCS	1850-1990MHz
CDMA	1920-2170MHz