



# SPECIFICATION SHEET

## CELLULAR ANTENNA

<b>MESSERS.</b>	
<b>DESCRIPTION</b>	<b>GSM/3G ANTENNA</b>
<b>PART No.</b>	<b>FES-7AAD</b>

ACCEPTANCE		
PREPARED	CHECKED	APPROVED
/	/	/

SUPPLIER		
PREPARED	CHECKED	APPROVED
		
<b>09/05</b>	<b>09/05</b>	<b>09/05</b>

**◆ INDEX**

— INDEX	-----	2
— REVISION HISTORY	-----	2
— APPLICATIONS	-----	3
— ELECTRICAL SPECIFICATION	-----	3
— MECHANICAL & ENVIRONMENTAL SPECIFICATION	-----	3
— ANTENNA DIMENSION	-----	4
— RADIATION PATTERN	-----	5-6

**◆ REVISION HISTORY**

NO	DATE	REVISION	NOTE	AUTHORS
1	2024.09.05	00	First Draft	LEE.

### ◆ APPLICATIONS

- MOBILE STATION, BASE STATION SYSTEM
- VOICE CALLS SHORT MESSAGES
- VEHICLE TRACKING ENERGY SYSTEM, MOBILE TV etc. OTHERS

### ◆ ELECTRICAL SPECIFICATION

ITEM		SPECIFICATIONS
Antenna	Frequency Range	824~960/1710~2170MHz
	Polarization	Linear
	Gain	2.0dBi (Zenith)
	V.S.W.R	< 2.5
	Impedance	50Ω

### ◆ MECHANICAL AND ENVIRONMENTAL SPECIFICATION

ITEM	SPECIFICATIONS
Cable	RG316 or others
Connector	SMA Male
Dimensions	Ø78.3x24.3±0.3mm
Operating Temperature	-40°C~+85°C
Vibration	10 to 55Hz with 1.5mm amplitude 2hours
Environmentally Friendly	ROHS Compliant

◆ ANTENNA DIMENSION

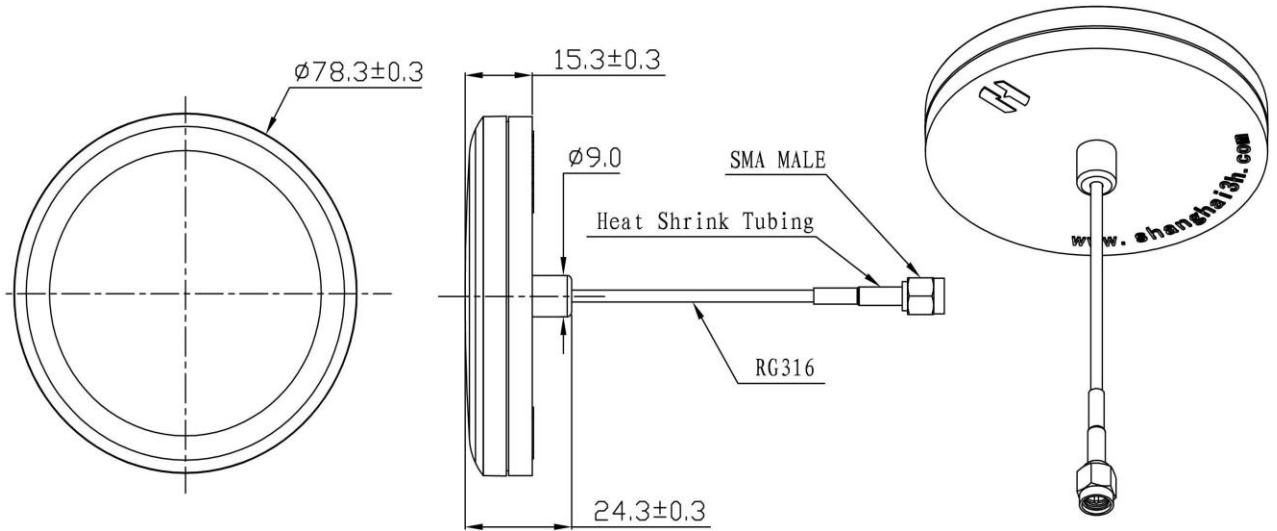

Unit: mm

➤ Customizable Cable and Connector

● ANTENNA IMAGE

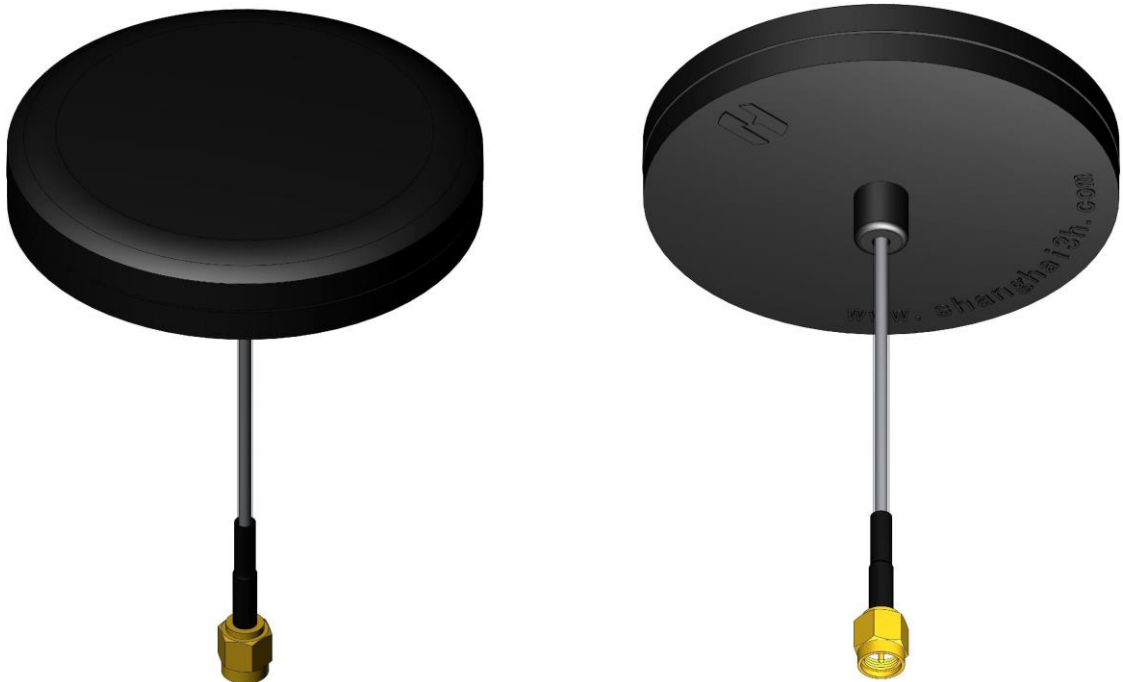

◆ RADIATION PATTERN

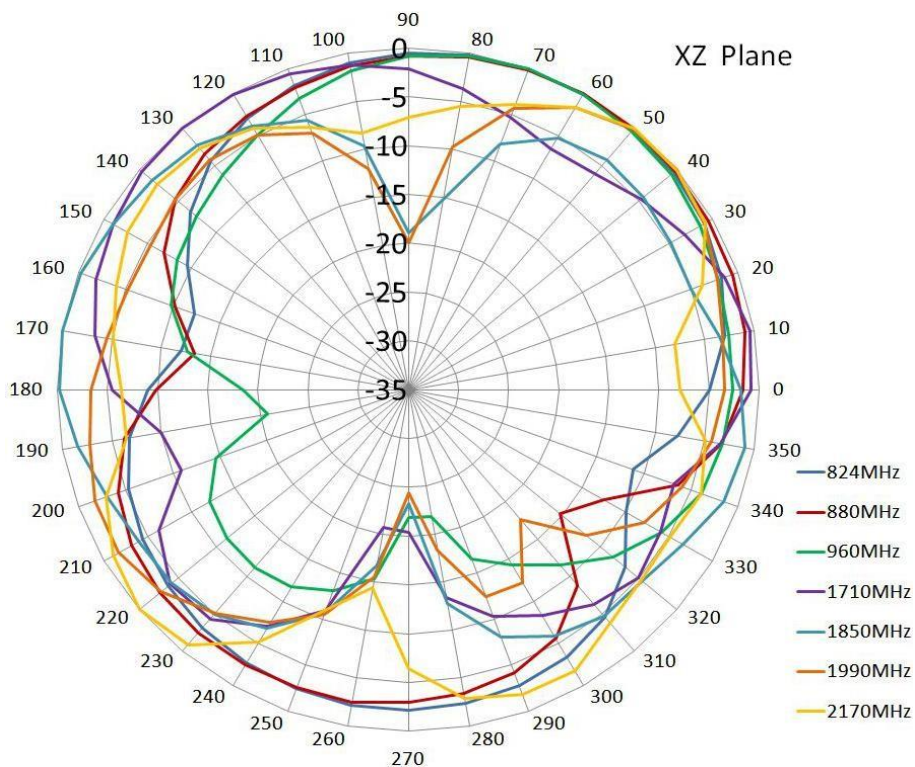
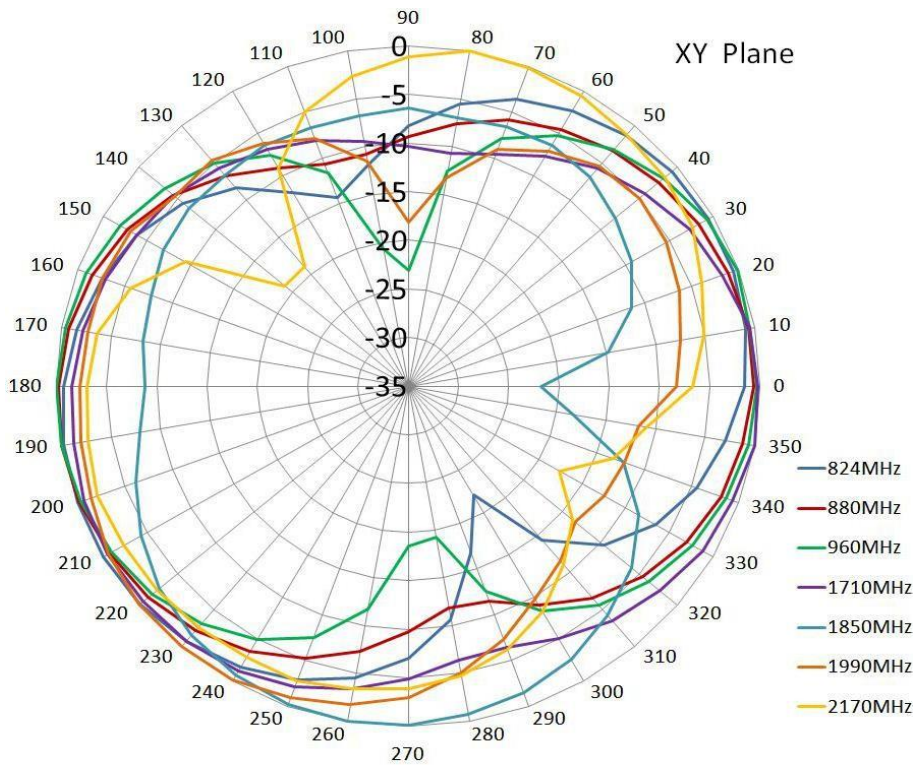

### ◆ RADIATION PATTERN

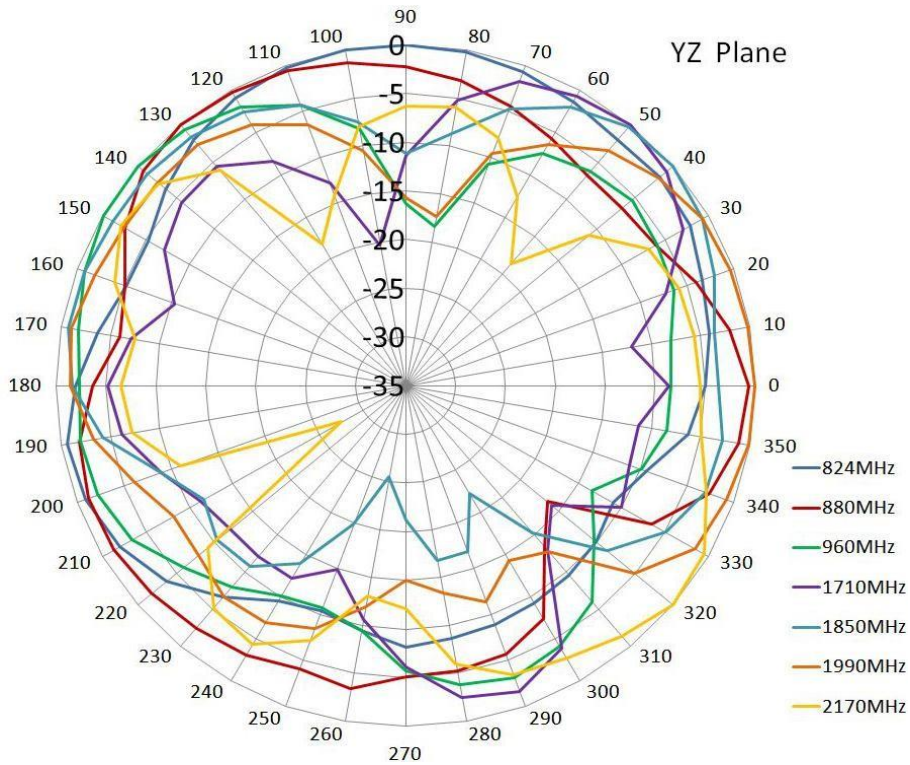

### ❖ 2G/3G FREQUENCY BAND

#### GSM/DCS/PCS/CDMA/GPRS BANDS

Bands	Frequency
GSM850	824-896MHz
GSM900	880-960MHz
DCS	1710-1880MHz
PCS	1850-1990MHz
CDMA	1920-2170MHz