



# SPECIFICATION SHEET

## LTE ANTENNA

<b>MESSERS.</b>	
<b>DESCRIPTION</b>	<b>4G ANTENNA</b>
<b>PART No.</b>	<b>FES-70EH</b>

ACCEPTANCE		
PREPARED	CHECKED	APPROVED
/	/	/

SUPPLIER		
PREPARED	CHECKED	APPROVED
		
<b>09/05</b>	<b>09/05</b>	<b>09/05</b>

## ◆ INDEX

— INDEX	-----	2
— REVISION HISTORY	-----	2
— APPLICATIONS	-----	3
— ELECTRICAL SPECIFICATION	-----	3
— MECHANICAL & ENVIRONMENTAL SPECIFICATION	-----	3
— ANTENNA DIMENSION	-----	4
— RADIATION PATTERN	-----	5-6

## ◆ REVISION HISTORY

NO	DATE	REVISION	NOTE	AUTHORS
1	2024.09.05	00	First Draft	LEE.

### ◆ APPLICATIONS

- WEARABLE DEVICES, GIS SYSTEM, MOBILE WEB
- FULL HD MOBILE TV, SMART METERING, AUTOMOTIVE
- GAMING SERVICES, ENERGY SYSTEM, SURVEY
- SMART BLACK BOX, VEHICLE TRACKING DEVICE
- MONITORING, HIGH SPEED DATA etc. OTHERS

### ◆ ELECTRICAL SPECIFICATION

ITEM		SPECIFICATIONS
Antenna	Frequency Range	824~960/1710~2170MHz
	Polarization	Linear
	Gain	2dBi (Zenith)
	V.S.W.R	< 2.0
	Impedance	50Ω

### ◆ MECHANICAL AND ENVIRONMENTAL SPECIFICATION

ITEM	SPECIFICATIONS
Cable	RG174 or others
Connector	SMA or others
Mounting Method	Screw
Dimensions	Ø50.0x48.0±0.5mm
Operating Temperature	-40°C~+85°C
Vibration	10 to 55Hz with 1.5mm amplitude 2hours
Environmentally Friendly	ROHS Compliant

◆ **ANTENNA DIMENSION**

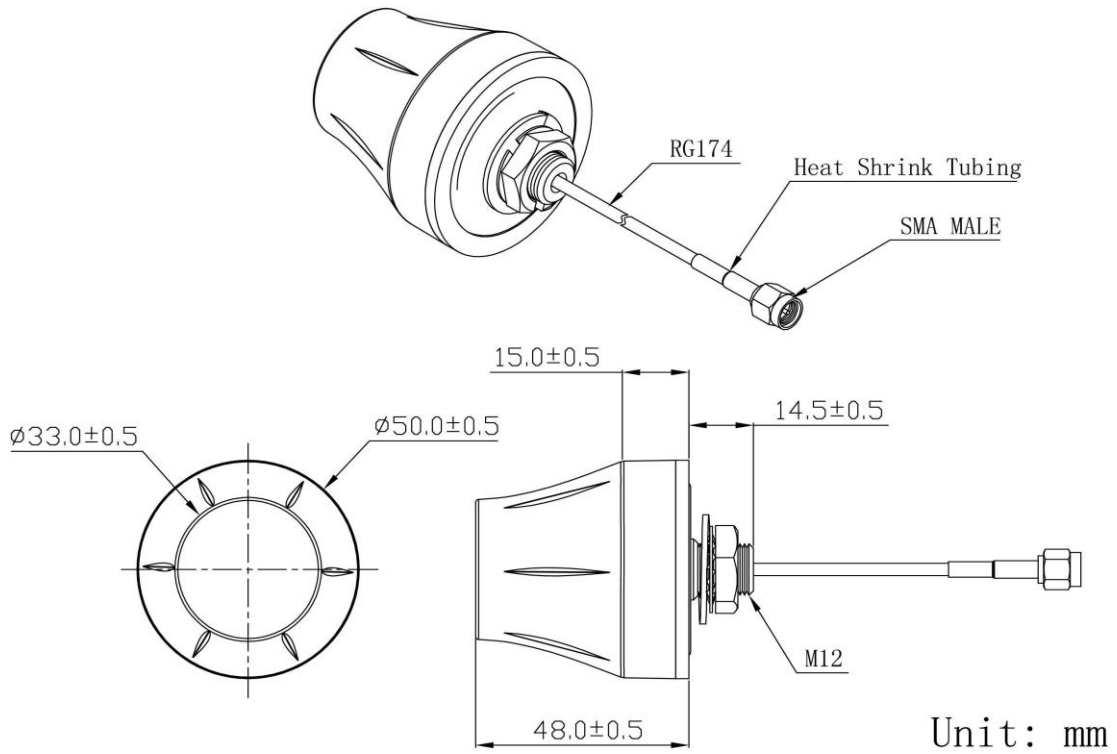

➤ **Customizable Cable and Connector**

● **ANTENNA IMAGE**



◆ RADIATION PATTERN

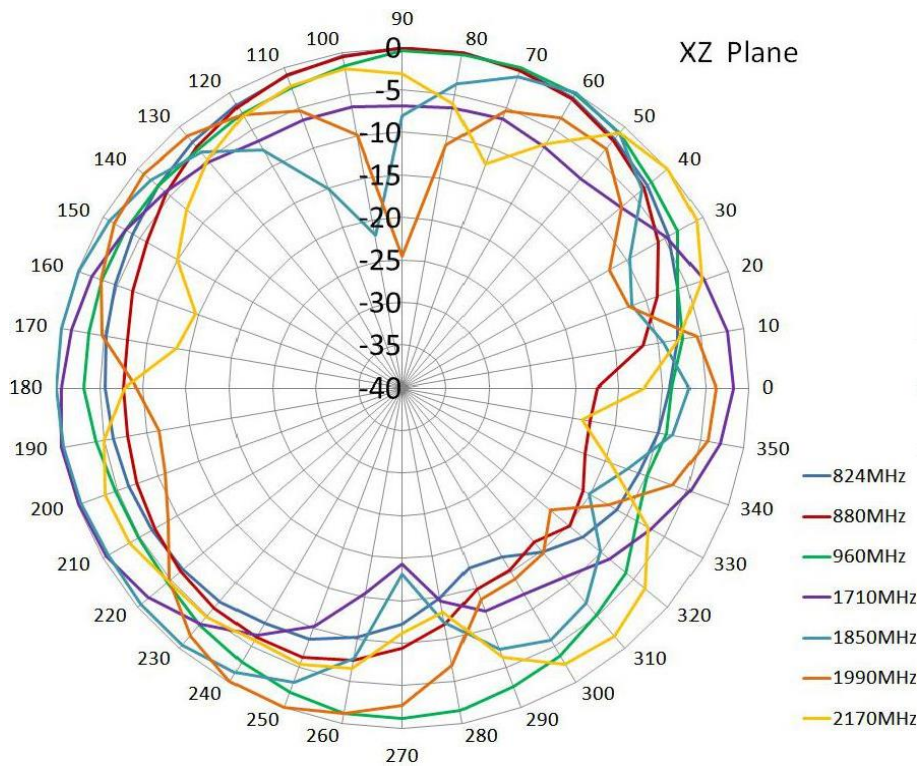
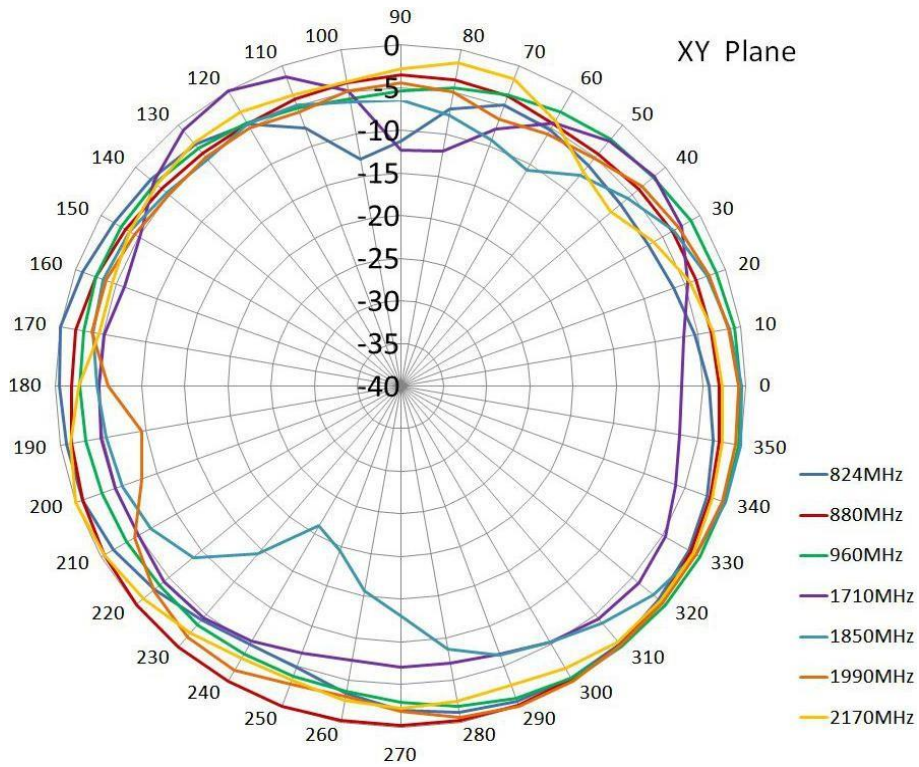

### ◆ RADIATION PATTERN

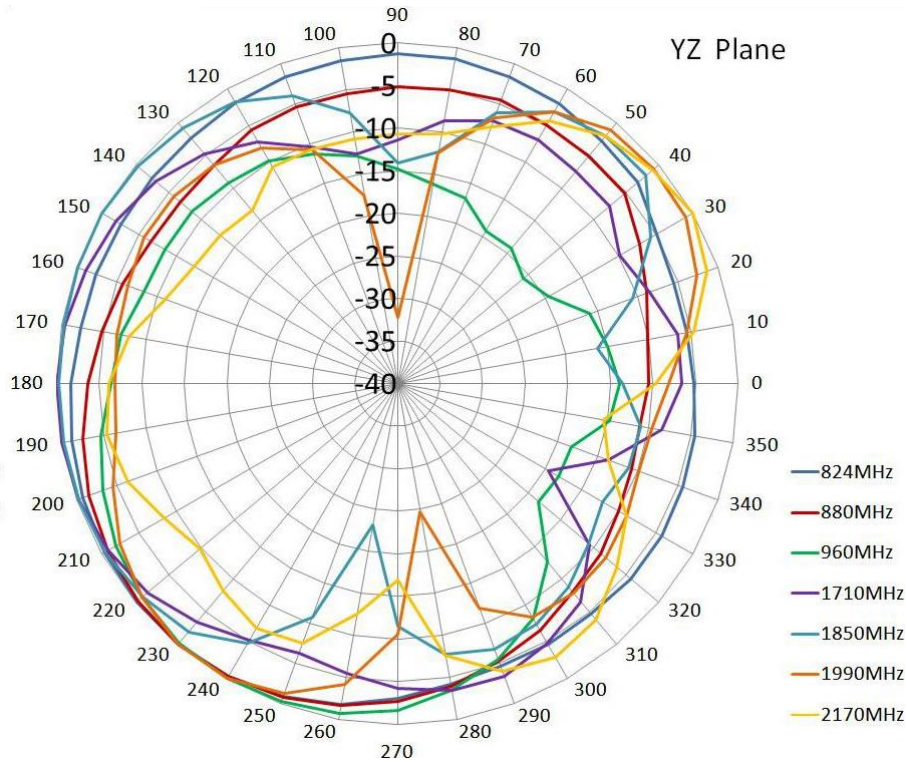

### ❖ 4G LTE FREQUENCY BANDS

Frequency	4G LTE Bands	3G Bands	2G Bands	CDMA Bands
698-960MHz 700/850/900MHz	B5 B6 B8 B12 B13 B14 B17 B18 B19 B20 B26 B27 B28 B29 B44 B67 B68 B85	B5 B6 B8 B12 B13 B14 B19 B20 B26	710 750 810 850 900	BC0 BC2 BC3 BC7 BC9 BC10 BC12 BC18 BC19
1710-2170MHz 1700/1800/1900/ 2000/2100MHz	B1 B2 B3 B4 B9 B10 B25 B33 B34 B35 B36 B37 B39 B65 B66 B70	B1 B2 B3 B4 B9 B10 B25 B33 B34 B35 B36 B37 B39	DCS(1800) PCS(1900)	BC1 BC4 BC6 BC8 BC14 BC15
2500-2690MHz 2500/2600MHz	B7 B38 B41 B69	B7 B38		BC13 BC16 BC20 BC21