



# SPECIFICATION SHEET

## CELLULAR ANTENNA

MESSERS.	
DESCRIPTION	GSM/3G ANTENNA
PART No.	FES-70BA

ACCEPTANCE		
PREPARED	CHECKED	APPROVED
/	/	/

SUPPLIER		
PREPARED	CHECKED	APPROVED
		
09/05	09/05	09/05

**◆ INDEX**

— INDEX	----- 2
— REVISION HISTORY	----- 2
— APPLICATIONS	----- 3
— ELECTRICAL SPECIFICATION	----- 3
— MECHANICAL & ENVIRONMENTAL SPECIFICATION	----- 3
— ANTENNA DIMENSION	----- 4
— RADIATION PATTERN	----- 5-6

**◆ REVISION HISTORY**

NO	DATE	REVISION	NOTE	AUTHORS
1	2024.09.05	00	First Draft	LEE.

### ◆ APPLICATIONS

- MOBILE STATION, BASE STATION SYSTEM
- VOICE CALLS SHORT MESSAGES
- VEHICLE TRACKING ENERGY SYSTEM, MOBILE TV etc. OTHERS

### ◆ ELECTRICAL SPECIFICATION

ITEM		SPECIFICATIONS
Antenna	Frequency Range	824~960/1710~1990MHz
	Polarization	Linear
	Gain	2dBi (Zenith)
	V.S.W.R	< 3.0
	Impedance	50Ω

### ◆ MECHANICAL AND ENVIRONMENTAL SPECIFICATION

ITEM	SPECIFICATIONS
Cable	RF1.37 or others
Connector	IPEX or others
Mounting Method	Adhesive
Dimensions	36.0x13.2x0.8±0.1mm
Operating Temperature	-40°C~+85°C
Vibration	10 to 55Hz with 1.5mm amplitude 2hours
Environmentally Friendly	ROHS Compliant

◆ **ANTENNA DIMENSION**

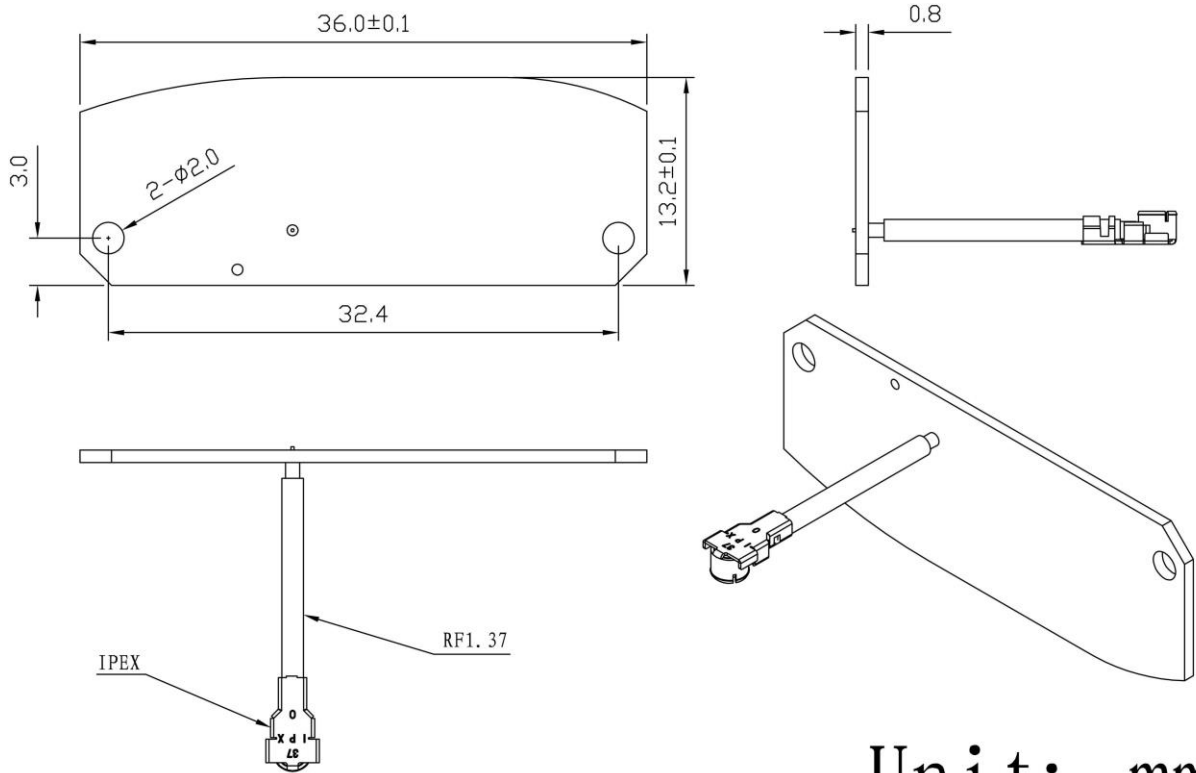

Unit: mm

➤ Customizable Cable and Connector

● **ANTENNA IMAGE**

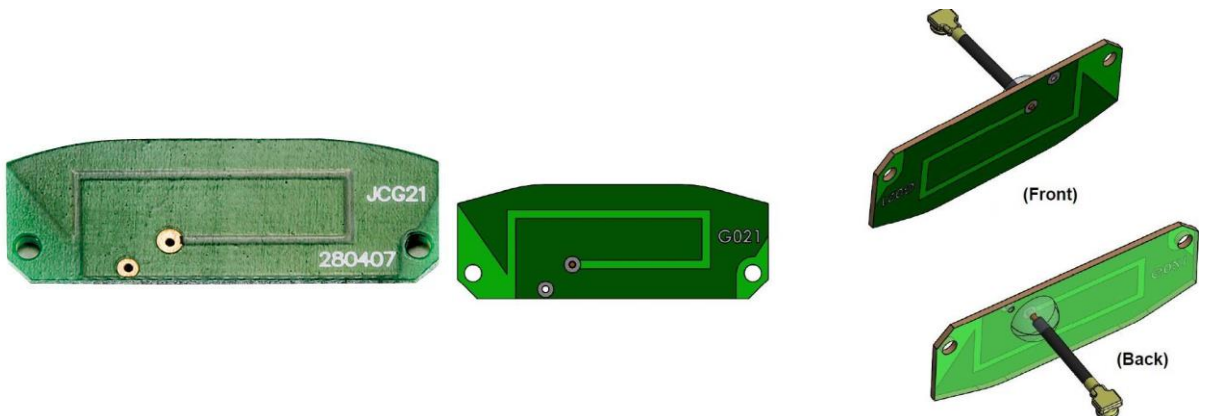

◆ RADIATION PATTERN

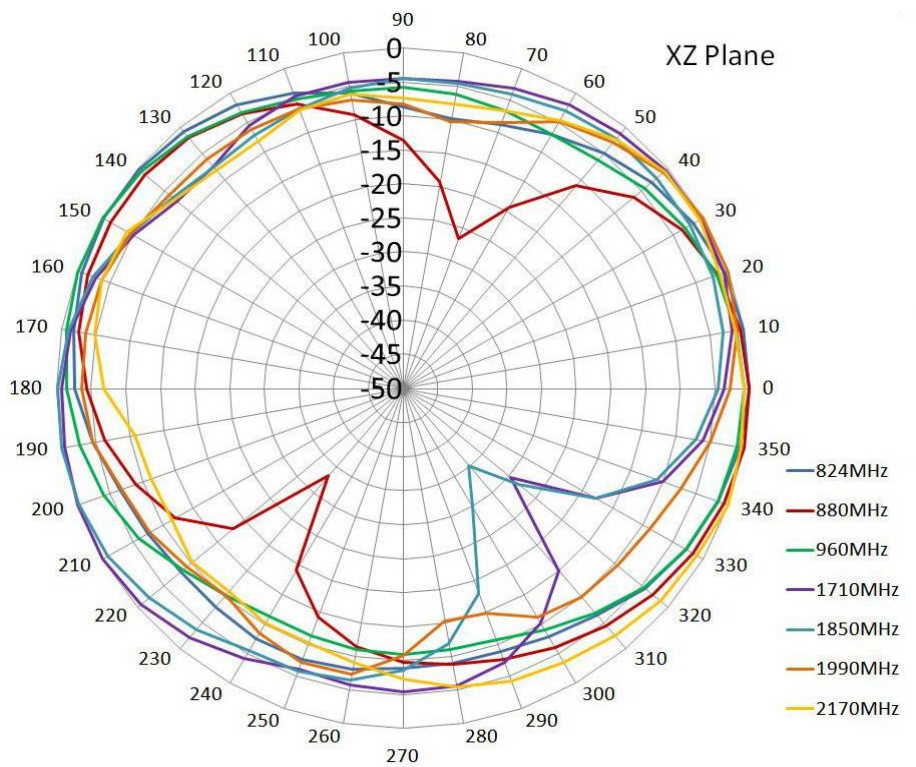
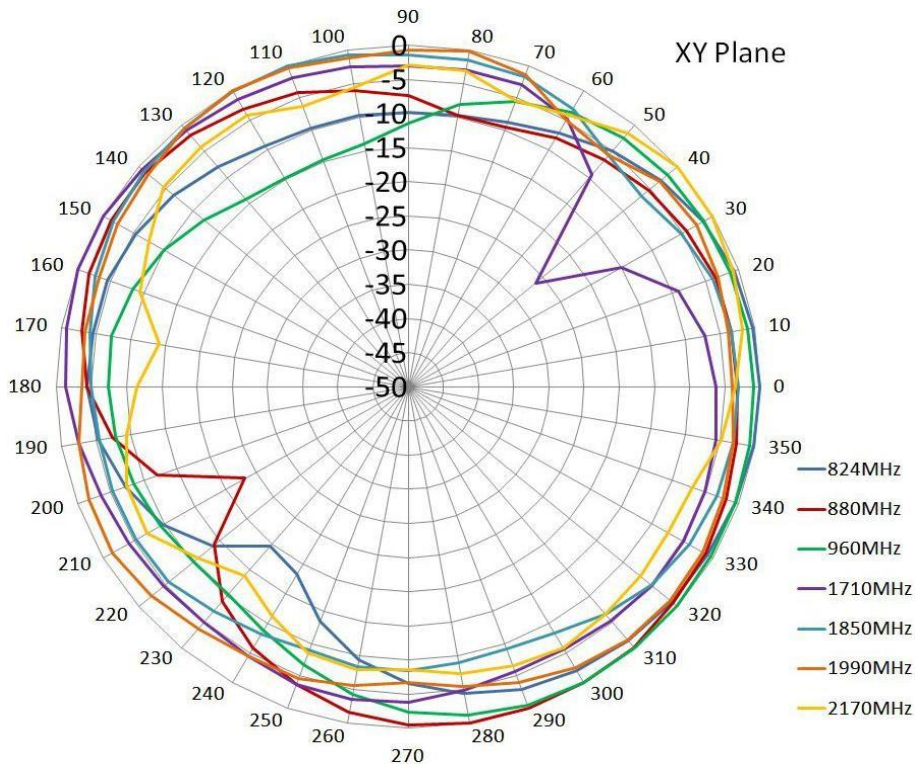

### ◆ RADIATION PATTERN

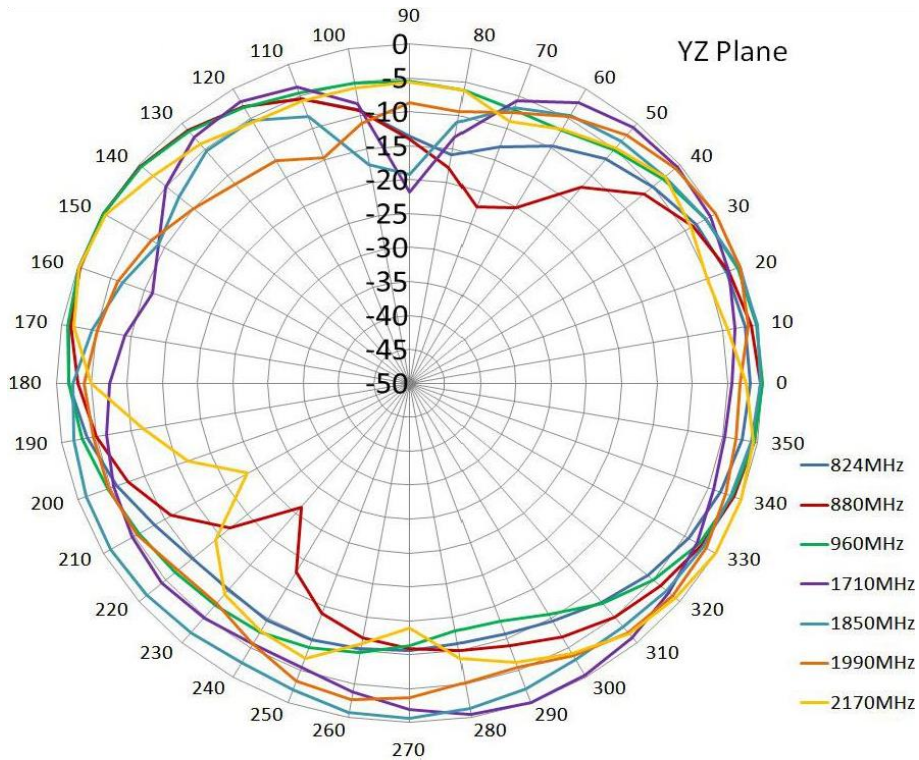

### ❖ 2G/3G FREQUENCY BAND

GSM/DCS/PCS/CDMA/GPRS BANDS	
Bands	Frequency
GSM850	824-896MHz
GSM900	880-960MHz
DCS	1710-1880MHz
PCS	1850-1990MHz
CDMA	1920-2170MHz