



SPECIFICATION SHEET

GNSS+4G LTE MIMO ANTENNA WIFI MIMOx4 Combination ANTENNA

| | |
|--------------------|---|
| MESSERS. | |
| DESCRIPTION | GNSS+4G LTE+WIFI Combination Antenna |
| PART No. | FES-5F0DLM4 |

| ACCEPTANCE | | |
|------------|---------|----------|
| PREPARED | CHECKED | APPROVED |
| | | |
| / | / | / |

| SUPPLIER | | |
|---|---|---|
| PREPARED | CHECKED | APPROVED |
|  |  |  |
| 10/02 | 10/02 | 10/02 |

◆ INDEX

| | |
|-------------------------------|-----------|
| — INDEX | ----- 2 |
| — REVISION HISTORY | ----- 2 |
| — APPLICATION | ----- 3 |
| — KEY FEATURES | ----- 3 |
| — ELECTRICAL SPECIFICATION | ----- 4 |
| — ENVIRONMENTAL SPECIFICATION | ----- 5 |
| — MECHANICAL SPECIFICATION | ----- 5 |
| — ANTENNA DIMENSION | ----- 6 |
| — RADIATION PATTERN | ----- 7-9 |

◆ REVISION HISTORY

| NO | DATE | REVISION | NOTE | AUTHORS |
|----|------------|----------|-------------|---------|
| 1 | 2024.10.02 | 00 | First Draft | LEE. |
| | | | | |
| | | | | |
| | | | | |
| | | | | |
| | | | | |
| | | | | |

◆ APPLICATION

- WEARABLE DEVICES, GIS SYSTEM, MOBILE WEB
- FULL HD MOBILE TV , SMART METERING,AUTOMOTIVE
- GAMING SERVICES ,ENERGY SYSTEM ,SURVEY
- SMART BLACK BOX ,VEHICLE TRACKING DEVICE
- MONITORING, HIGH SPEED DATA etc. OTHERS

◆ KEY FEATURES

- GPS&GLONASS + 4G LTE MIMO + WIFI MIMOx4 Combination Antenna
- 7 x 1 Combination Antenna
- 4G LTE Gain:3dBi / WIFI Gain:2dBi
- Frequency : 698-960MHz/1710-2690MHz,2400~2483.MHz/4900~5825MHz
- GPS&GLONASS ANTENNA
- Active GNSS Gain 28 ± 2 dB
- GNSS Voltage Range 3.0V~5.0V



◆ 4G LTE ANTENNA ELECTRICAL SPECIFICATION

| ITEM | | SPECIFICATIONS |
|---------------------------|-----------------|----------------------|
| 4G LTE Antenna MIMO | Frequency Range | 698~960/1710~2690MHz |
| | Polarization | Linear |
| | Gain | 3.0dBi |
| | V.S.W.R(min) | < 3.0 |
| | Impedance | 50Ω |

◆ WIFI DUAL ANTENNA ELECTRICAL SPECIFICATION

| ITEM | | SPECIFICATIONS |
|---------------------------|-----------------|-----------------------------|
| WIFI Antenna MIMOx4 | Frequency Range | 2480~2483.5MHz/4900~5825MHz |
| | Polarization | Linear |
| | Gain | 2.0dBi |
| | V.S.W.R(min) | < 2.5 |
| | Impedance | 50Ω |

◆ GNSS ANTENNA ELECTRICAL SPECIFICATION

| ITEM | | SPECIFICATIONS |
|-----------------|---------------------|-----------------------------------|
| GNSS Antenna | Frequency | GPS L1/GLONASS G1/QZSS/GALILEO E1 |
| | Polarization | RHCP Right-hand-circulator |
| | Impedance | 50Ω |
| GNSS LNA | Gain | 28 ± 2dB |
| | Supply Voltage | 3.0-5.0V |
| | Current Consumption | ≤15mA Typ. |
| | V.S.W.R | ≤2.0 |

◆ ENVIRONMENTAL SPECIFICATION

| ITEM | SPECIFICATIONS |
|-----------------------|----------------|
| Operating Temperature | -40°C~+85°C |
| Storage Temperature | -40°C~+85°C |
| Relative Humidity | 65°C, 95%RH |
| Waterproof Rating | IP67 |

RoHS Compliant

◆ MECHANICAL SPECIFICATION

| ITEM | SPECIFICATIONS |
|-----------------|------------------|
| Dimensions | Ø110.0x53.0mm |
| Cable | RG174 x 7 |
| Connector | SMA(M) or others |
| Radome | ABS |
| Mounting Method | Screw |

❖ GNSS FREQUENCY BAND

| GPS/GNSS FREQUENCY BAND | | | | | |
|-------------------------|------------|---------|---------|---------|---------|
| GPS /QZSS | L1 | L2 | L5 | L6 | |
| | 1575.42MHz | 1227MHz | 1176MHz | 1278MHz | |
| GLONASS | G1 | G2 | G3 | | |
| | 1602MHz | 1248MHz | 1207MHz | | |
| GALILEO | E1 | E5a | E5b | E6 | |
| | 1575.42MHz | 1176MHz | 1202MHz | 1278MHz | |
| BEIDOU | B1 | B2a | B2b | B3 | |
| | 1561MHz | 1176MHz | 1207MHz | 1268MHz | |
| SBAS | L1 | G1 | L5 | G2 | G3 |
| | 1575.42MHz | 1602MHz | 1176MHz | 1248MHz | 1207MHz |
| L-BAND IRNSS | L-BAND | IRNSS | | | |
| | 1542MHz | 1176MHz | | | |

❖ 4G LTE FREQUENCY BANDS

| Frequency | | 4G LTE Bands | 3G Bands | 2G Bands | CDMA Bands |
|--------------|--------------------------------|--|--|------------------------|--|
| 698-960MHz | 700/850/900MHz | B5 B6 B8 B12 B13 B14 B17 B18 B19 B20 B26 B27 B28 B29 B44 B67 B68 B85 | B5 B6 B8 B12 B13 B14 B19 B20 B26 | 710 750 810 850 900 | BC0 BC2 BC3 BC7 BC9 BC10 BC12 BC18 BC19 |
| 1710-2170MHz | 1700/1800/1900/ 200/2100MHz | B1 B2 B3 B4 B9 B10 B25 B33 B34 B35 B36 B37 B39 B65 B66 B70 | B1 B2 B3 B4 B9 B10 B25 B33 B34 B35 B36 B37 B39 | DCS(1800) PCS(1900) | BC1 BC4 BC6 BC8 BC14 BC15 |
| 2500-2690MHz | 2500/2600MHz | B7 B38 B41 B69 | B7 B38 | | BC13 BC16 BC20 BC21 |

◆ ANTENNA DIMENSION

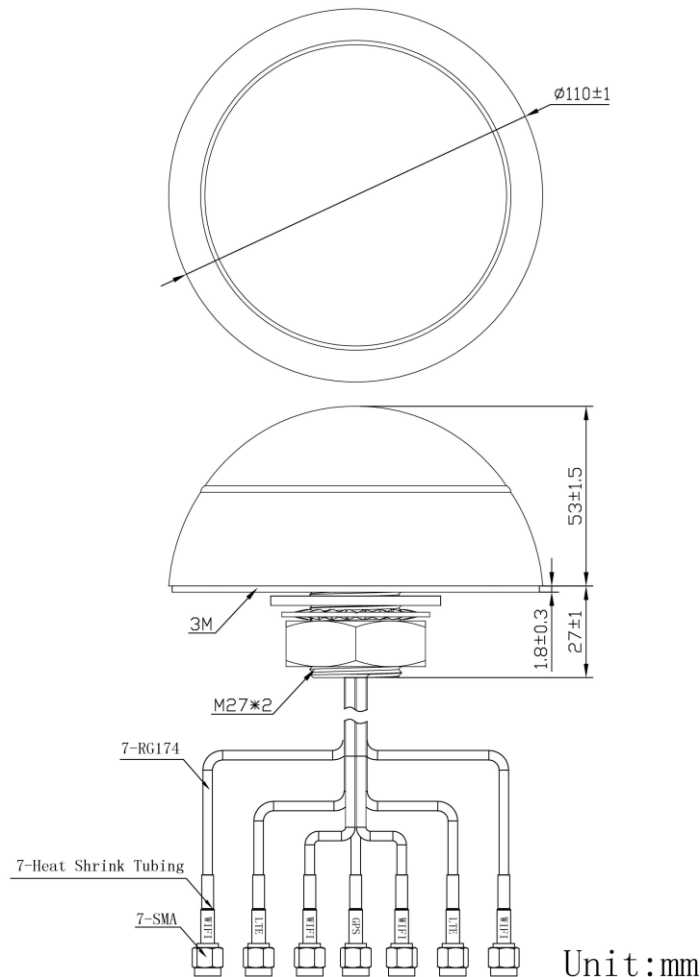

◆ Radiation Pattern(GPS L1)

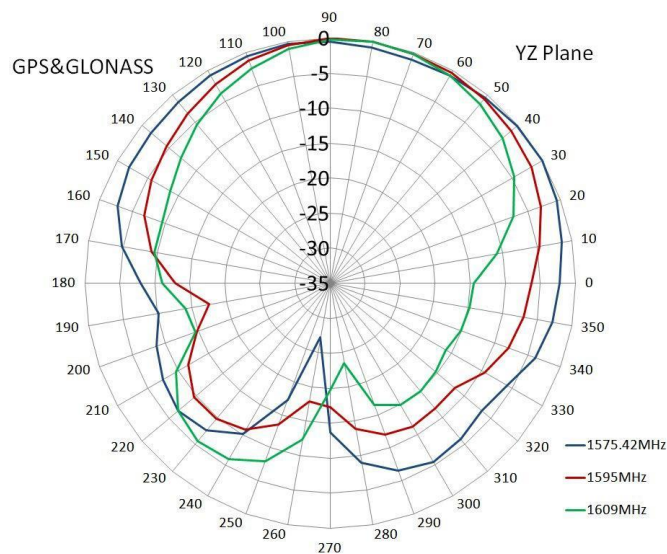
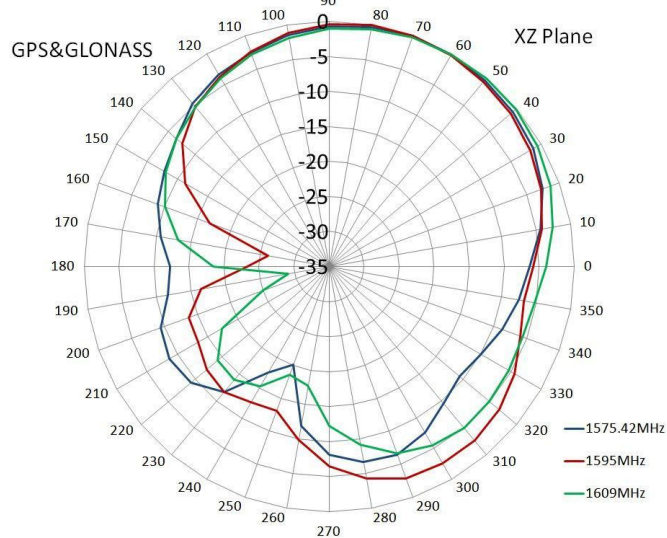
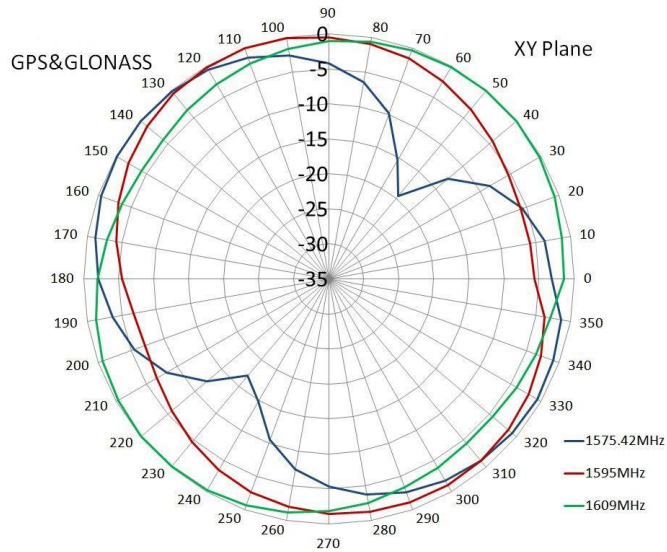

◆ Radiation Pattern(4G LTE)

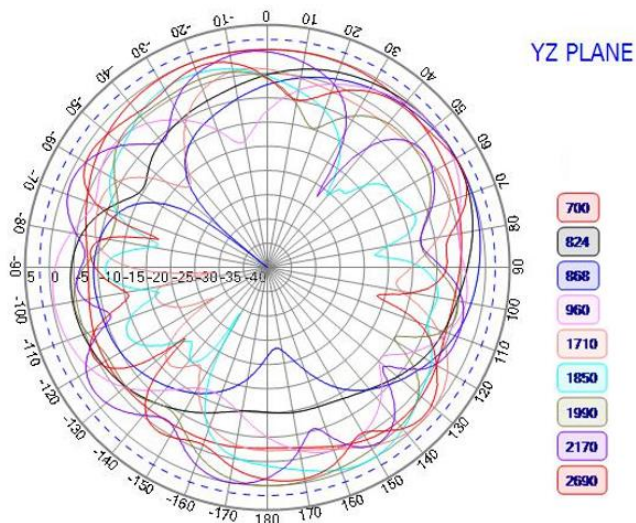
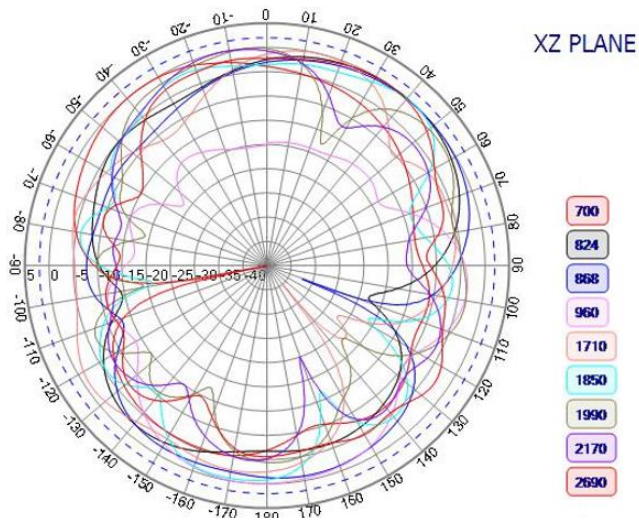
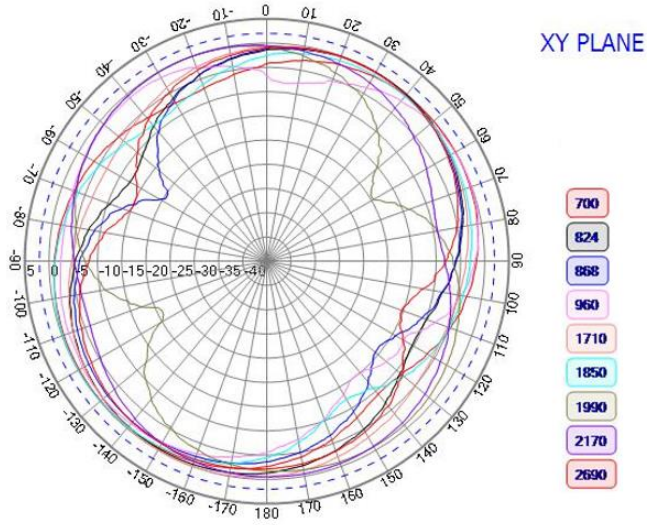

◆ Radiation Pattern(WIFI)

