



# SPECIFICATION SHEET

## High Precision GNSS Antenna 5G NR MINOX4 Combination Antenna

<b>MESSERS.</b>	
<b>DESCRIPTION</b>	<b>GNSS+5G NR MINOX4 Combination Antenna</b>
<b>PART No.</b>	<b>FES-2F0ENR4</b>

ACCEPTANCE		
PREPARED	CHECKED	APPROVED
/	/	/

SUPPLIER		
PREPARED	CHECKED	APPROVED
		
10/02	10/02	10/02

**◆ INDEX**

— INDEX	----- 2
— REVISION HISTORY	----- 2
— APPLICATION	----- 3
— KEY FEATURES	----- 3
— ELECTRICAL SPECIFICATION	----- 4
— ENVIRONMENTAL SPECIFICATION	----- 5
— MECHANICAL SPECIFICATION	----- 5
— ANTENNA DIMENSION	----- 6
— RADIATION PATTERN	----- 7-14

**◆ REVISION HISTORY**

NO	DATE	REVISION	NOTE	AUTHORS
1	2024.10.02	00	First Draft	LEE.

**◆ APPLICATION**

- MOBILIZING MEDIA AND ENTERTAINMENT
- ABUNDANT USER-GENERATED CONTENT
- HIGH-SPEED MOBILITY
- CONNECTED CLOUD COMPUTING
- IMMERSIVE EXPERIENCES
- CONNECTED VEHICLE
- SAFETY CONSCIOUS AUTONOMOUS TRANSPORTATION
- SMARTER AGRICULTURE
- AUGMENTED REALITY
- ENHANCED COMMUNICATION INFRASTRUCTURE FOR PUBLIC SAFETY, TRAFFIC MANAGEMENT, POLICE, FIRE, AND AMBULANCE SERVICES AND OTHER URBAN APPLICATIONS.

**◆ KEY FEATURES**

- 5G NR/4G LTE ANTENNA (MIMO), GPS/GLONASS/BEIDOU/GALILEO/QZSS/RTK/L1/L2/L5
- 5 x 1 Combination Antenna
- 4G/5G NR Gain 4dBi
- Frequency : 698-960MHz/1710-2690MHz/2900-5000MHz
- GNSS L1/L2/L5 ANTENNA
- Active GNSS L1/L2/L5 Gain  $40 \pm 2$ dB
- GNSS Voltage Range 3.0V~12.0V



**◆ 5G NR ANTENNA ELECTRICAL SPECIFICATION**

ITEM		SPECIFICATIONS
4G/5G NR Antenna MIMOx4	Frequency Range	698~960/1710~2690MHz/2900~5000MHz
	Polarization	Linear
	Gain	4.0dBi Typ.
	V.S.W.R(min)	< 3.0
	Impedance	50Ω

**◆ GNSS ANTENNA ELECTRICAL SPECIFICATION**

ITEM		SPECIFICATIONS
GNSS Antenna	Frequency	GPS L1/L2/L5 GLONASS G1/G2/G3 BEIDOU B1//B2a/B2b/B3 Galileo E1/E5a/E5b/E6
	Polarization	RHCP Right-hand-circulator
	Axial Ratio(min)	≤3dB
	V.S.W.R	≤2.0
	Peak Gain	≥5.0dBi
	Impedance	50Ω
GNSS LNA	Gain	40 ± 2dB
	Supply Voltage	3.0-12.0V
	Current Consumption	≤60mA Typ.
	V.S.W.R	≤2.0

**◆ ENVIRONMENTAL SPECIFICATION**

ITEM	SPECIFICATIONS
Operating Temperature	-40°C~+85°C
Storage Temperature	-40°C~+85°C
Relative Humidity	65°C, 95%RH
Waterproof Rating	IP67

RoHS Compliant

**◆ MECHANICAL SPECIFICATION**

ITEM	SPECIFICATIONS
Dimensions	189.0x182.0x85.0mm
Cable	LMR100 x 5
Connector	SMA(M) or others
Radome	PC/ABS
Mounting Method	Screw

**❖ GNSS FREQUENCY BAND**

GPS/GNSS FREQUENCY BAND					
GPS /QZSS	L1	L2	L5	L6	
	1575.42MHz	1227MHz	1176MHz	1278MHz	
GLONASS	G1	G2	G3		
	1602MHz	1248MHz	1207MHz		
GALILEO	E1	E5a	E5b	E6	
	1575.42MHz	1176MHz	1202MHz	1278MHz	
BEIDOU	B1	B2a	B2b	B3	
	1561MHz	1176MHz	1207MHz	1268MHz	
SBAS	L1	G1	L5	G2	G3
	1575.42MHz	1602MHz	1176MHz	1248MHz	1207MHz
L-BAND IRNSS	L-BAND	IRNSS			
	1542MHz	1176MHz			

**❖ 4G/5G NR FREQUENCY BANDS**

Frequency	5G NR Bands	4G LTE Bands	3G Bands	2G Bands	CDMA Bands
617-960 MHz 600/700/ 850/900MHz	n5 n8 n12 n20 n28 n71 n81 n82 n83	B5 B6 B8 B12 B13 B14 B17 B18 B19 B20 B26 B27 B28 B29 B44 B67 B68 B71 B85	B5 B6 B8 B12 B13 B14 B19 B20 B26	710 750 810 850 900	BC0 BC2 BC3 BC7 BC9 BC10 BC12 BC18 BC19
1427-2690MHz 1500/1600/1700 1800/1900/2000 2100/2300/2500 2600MHz	n1 n2 n3 n7 n25 n34 n38 n39 n40 n41 n50 n51 n66 N70 n74 n75 n76 n80 n84 n86	B1 B2 B3 B4 B7 B9 B10 B11 B21 B23 B24 B25 B30 B32 B33 B34 B35 B36 B37 B38 B39 B40 B41 B45 B50 B51 B65 B66 B69 B70 B74 B75 B76	B1 B2 B3 B4 B7 B9 B10 B11 B21 B25 B32 B33 B34 B35 B36 B37 B38 B39 B40	DCS(1800) PCS(1900)	BC1 BC4 BC6 BC8 BC13 BC14 BC15 BC16 BC20 BC21
3300-5000MHz 3300/3500/3600 3700/4500MHz	n77 n78 n79	B22 B42 B43 B48 B49 B52	B22		
5150-5925MHz 5200/5500 5800MHz		B46 B47 B252 B255			

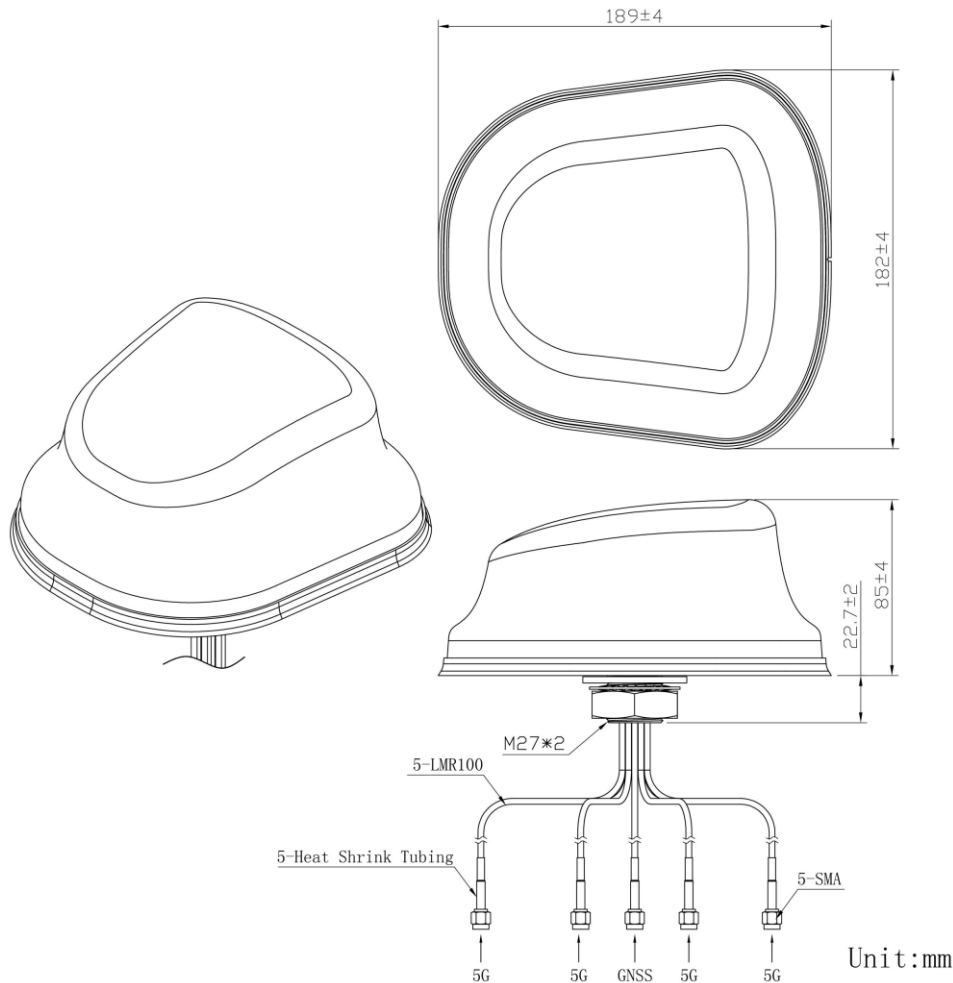
**◆ ANTENNA DIMENSION**

◆ Radiation Pattern(GNSS L1)

XY-PLANE

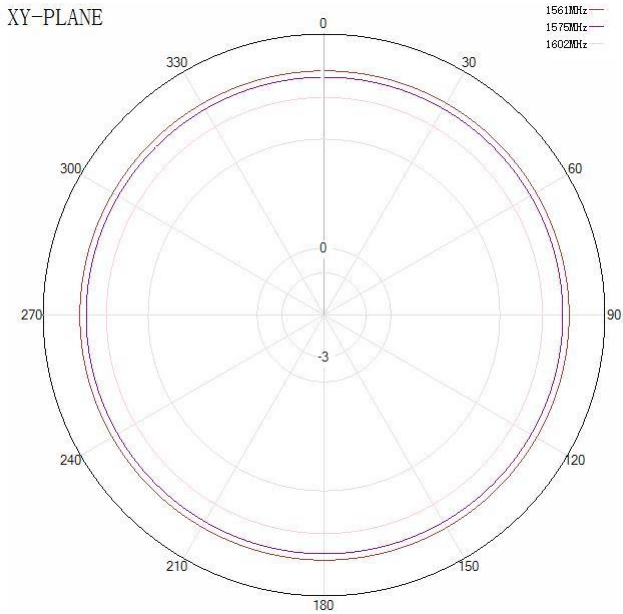

XZ-PLANE

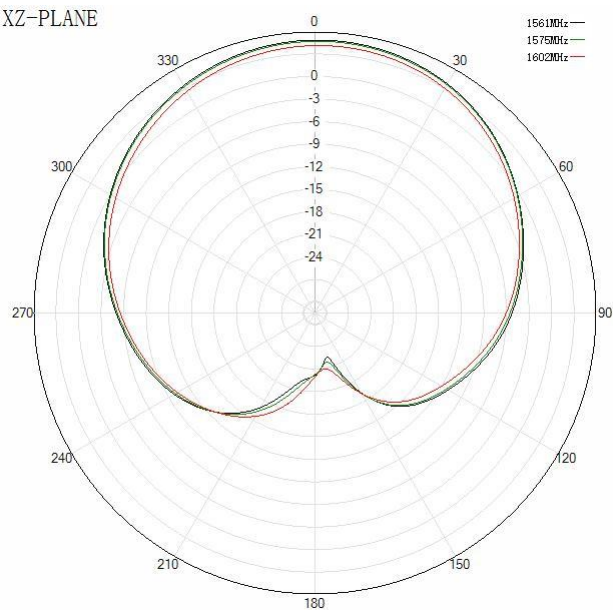

YZ-PLANE

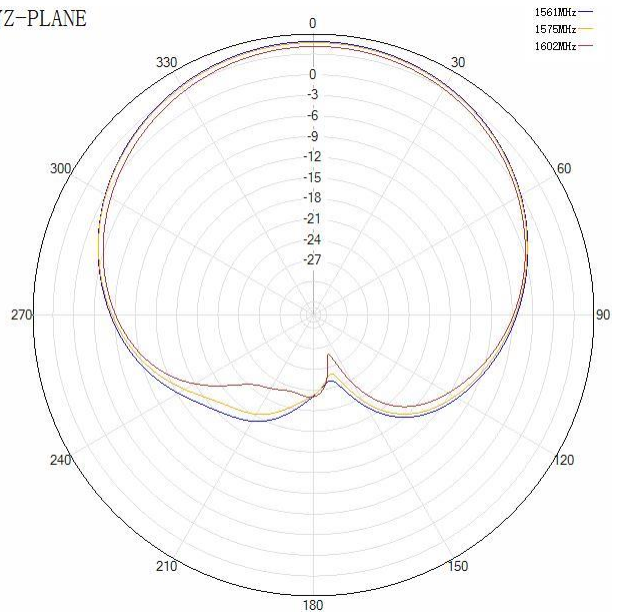

◆ Radiation Pattern(GNSS L2/L5)

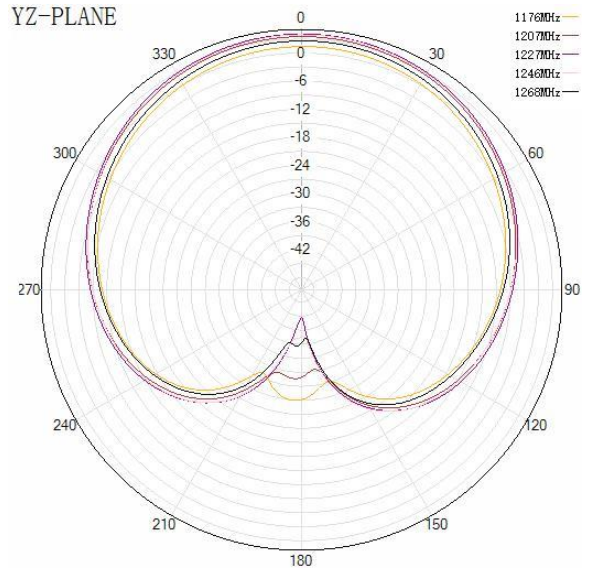
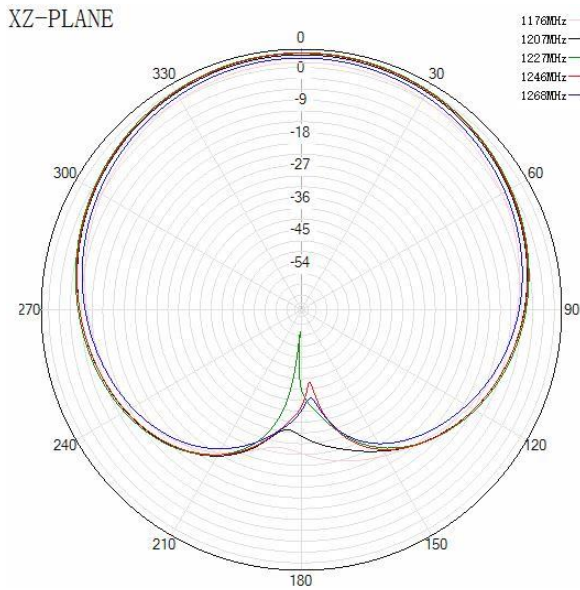
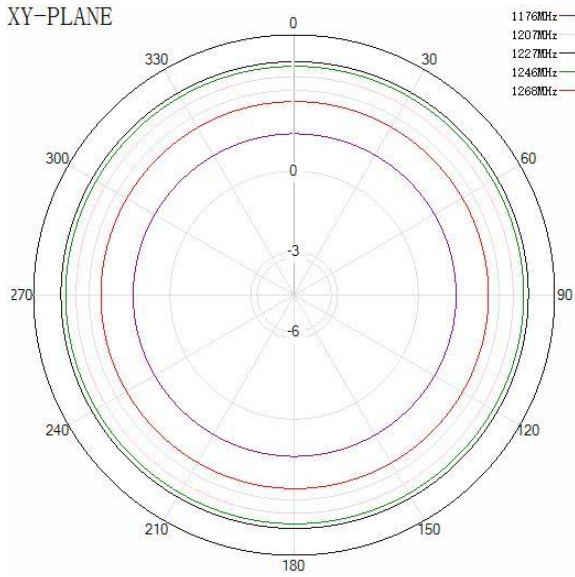



◆ Radiation Pattern(5G NR)

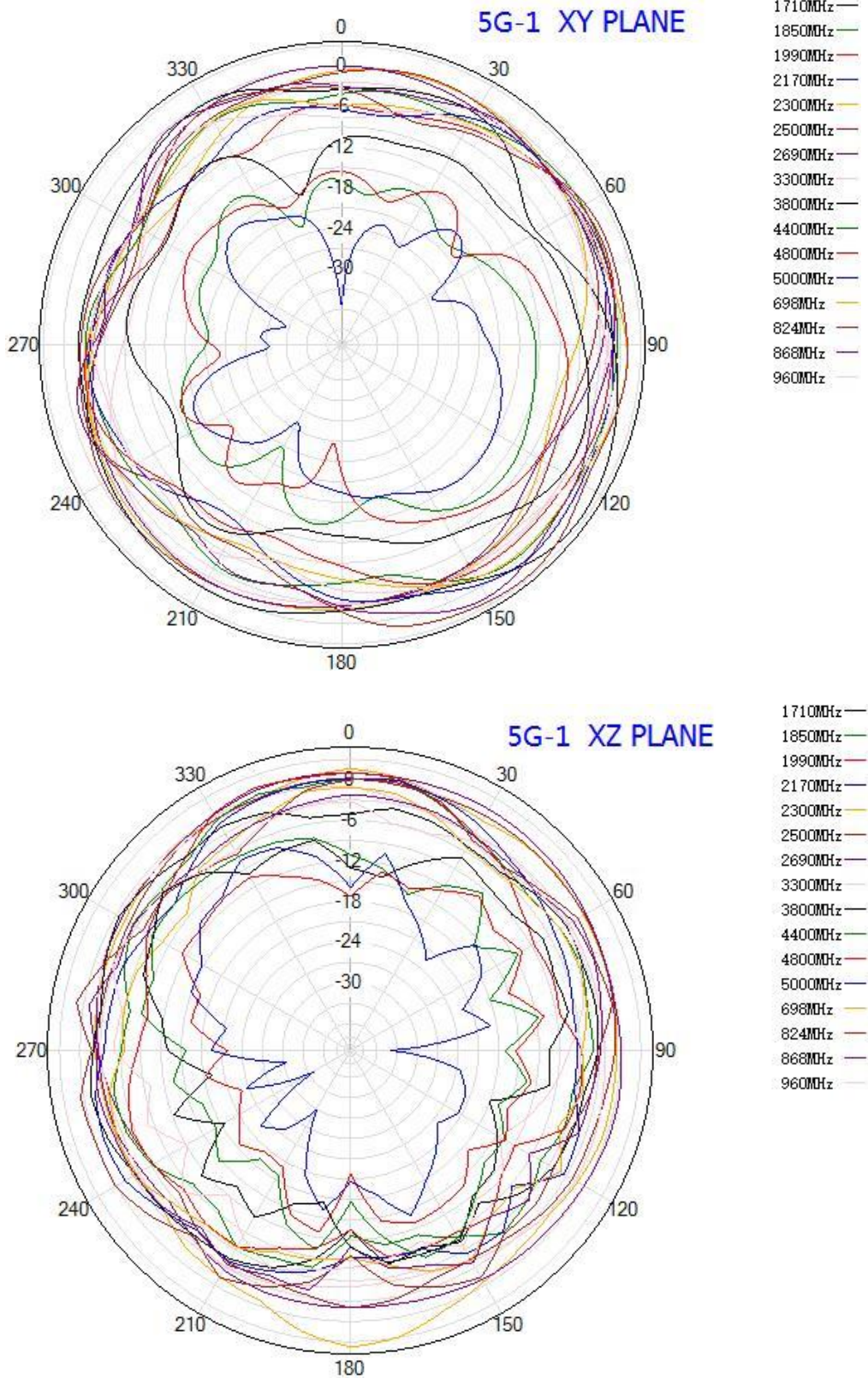

◆ Radiation Pattern(5G NR)

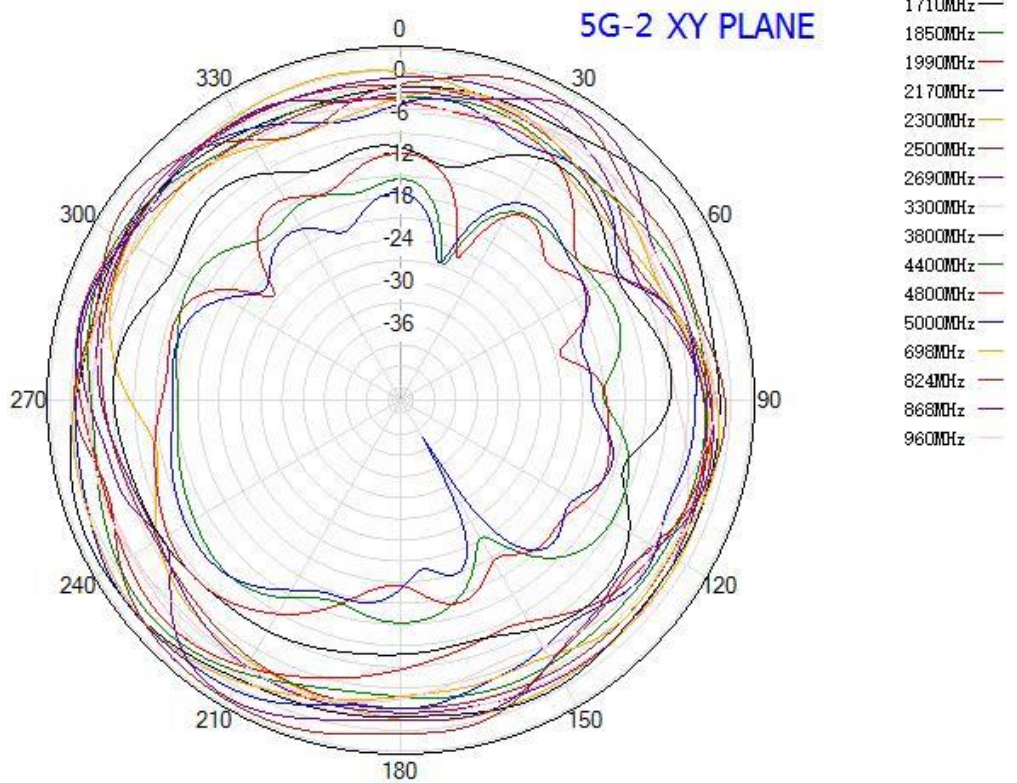
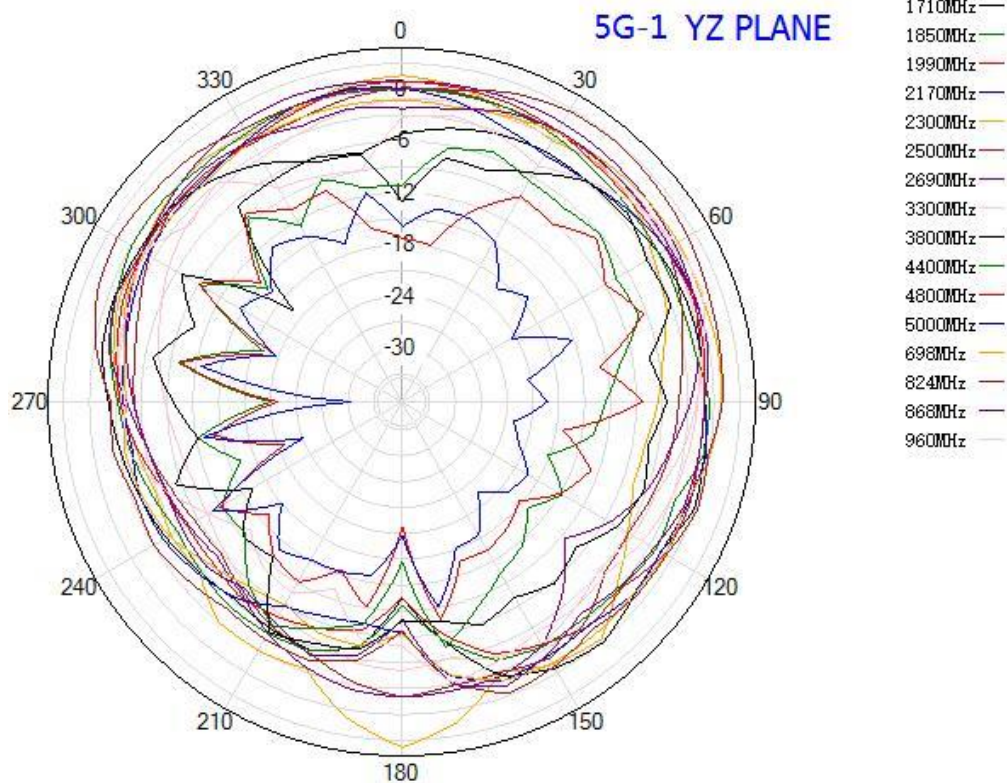

◆ Radiation Pattern(5G NR)

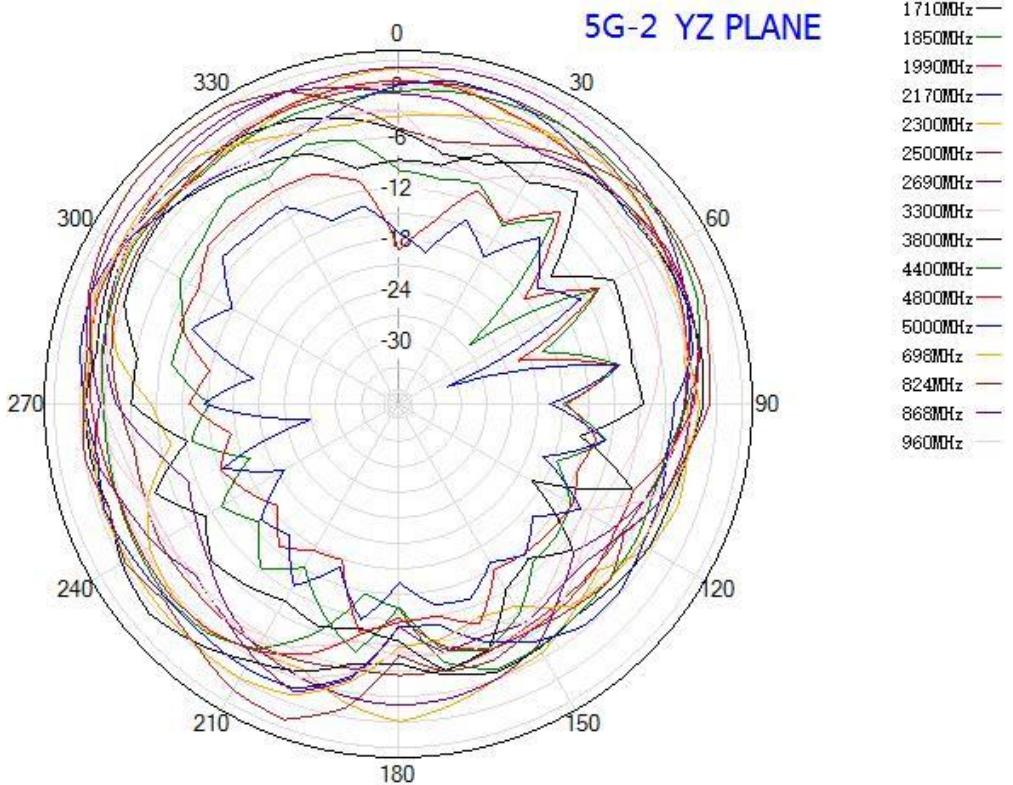
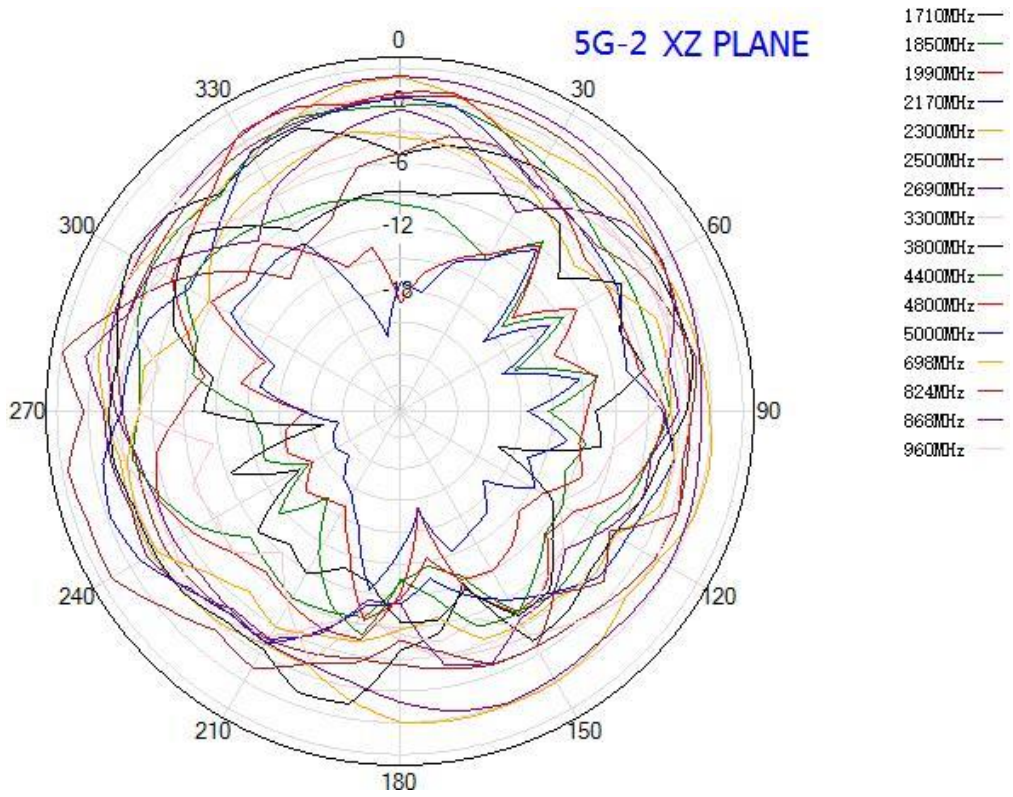

◆ Radiation Pattern(5G NR)

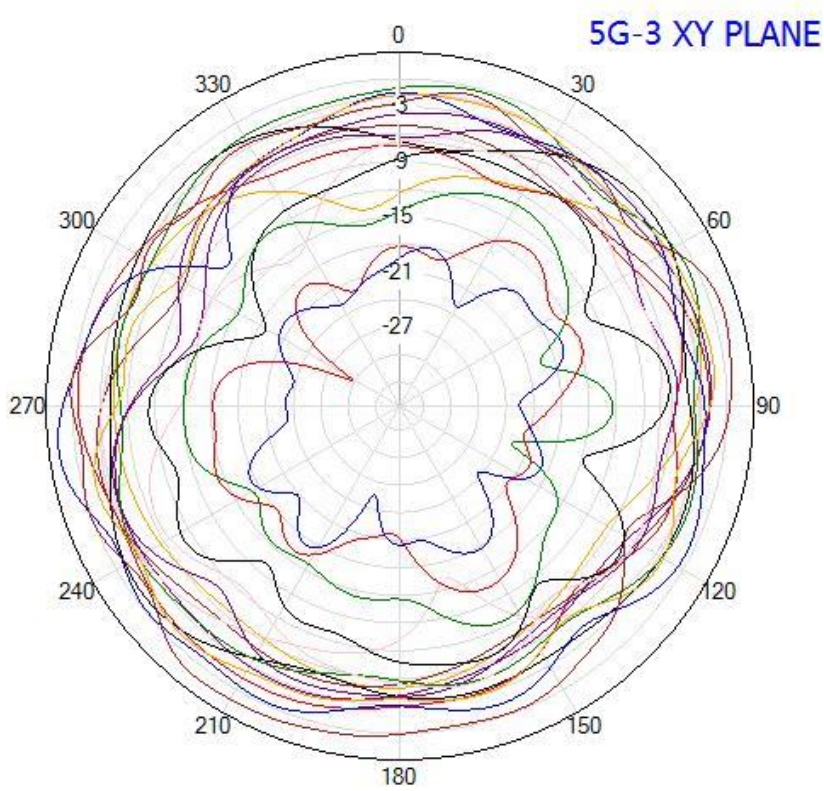

- 1710MHz —
- 1850MHz —
- 1990MHz —
- 2170MHz —
- 2300MHz —
- 2500MHz —
- 2690MHz —
- 3300MHz —
- 3800MHz —
- 4400MHz —
- 4800MHz —
- 5000MHz —
- 698MHz —
- 824MHz —
- 868MHz —
- 960MHz —

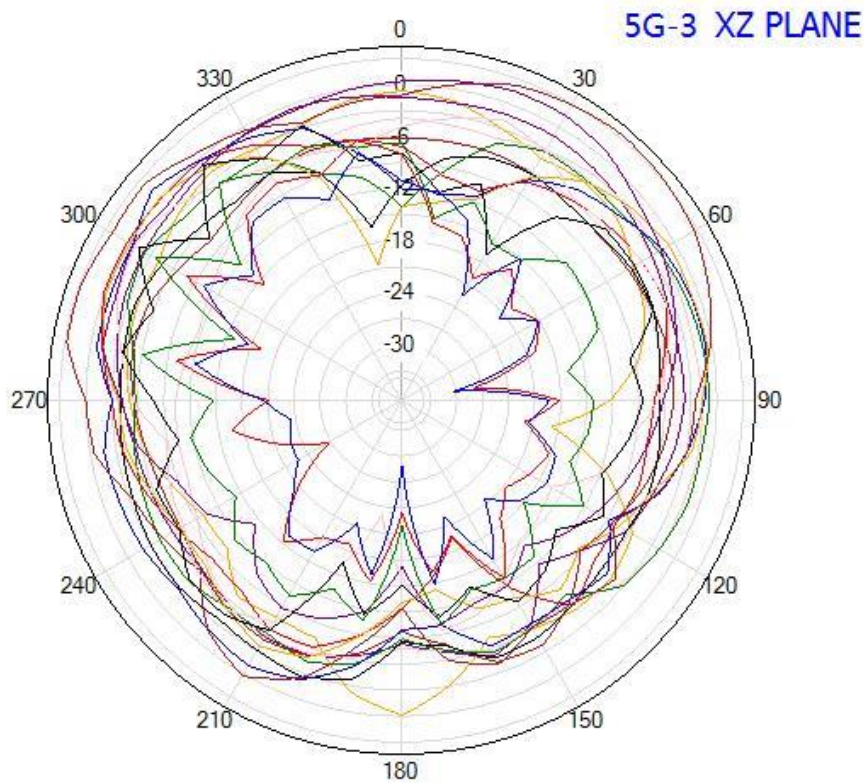

- 1710MHz —
- 1850MHz —
- 1990MHz —
- 2170MHz —
- 2300MHz —
- 2500MHz —
- 2690MHz —
- 3300MHz —
- 3800MHz —
- 4400MHz —
- 4800MHz —
- 5000MHz —
- 698MHz —
- 824MHz —
- 868MHz —
- 960MHz —

◆ Radiation Pattern(5G NR)

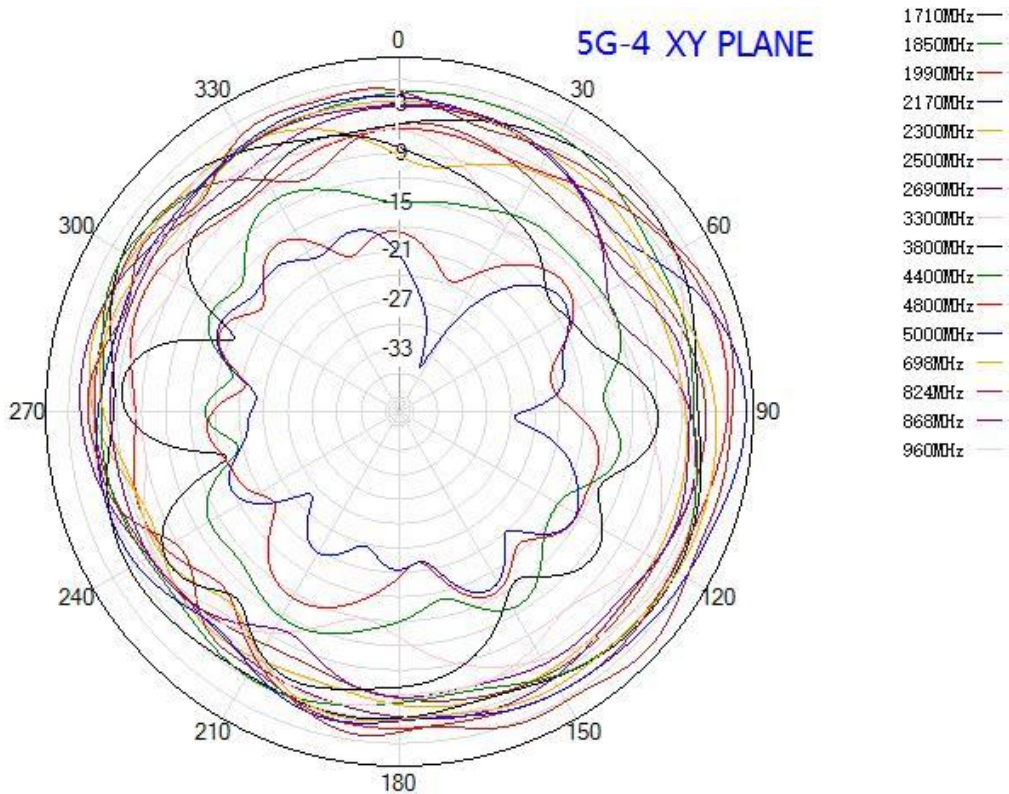
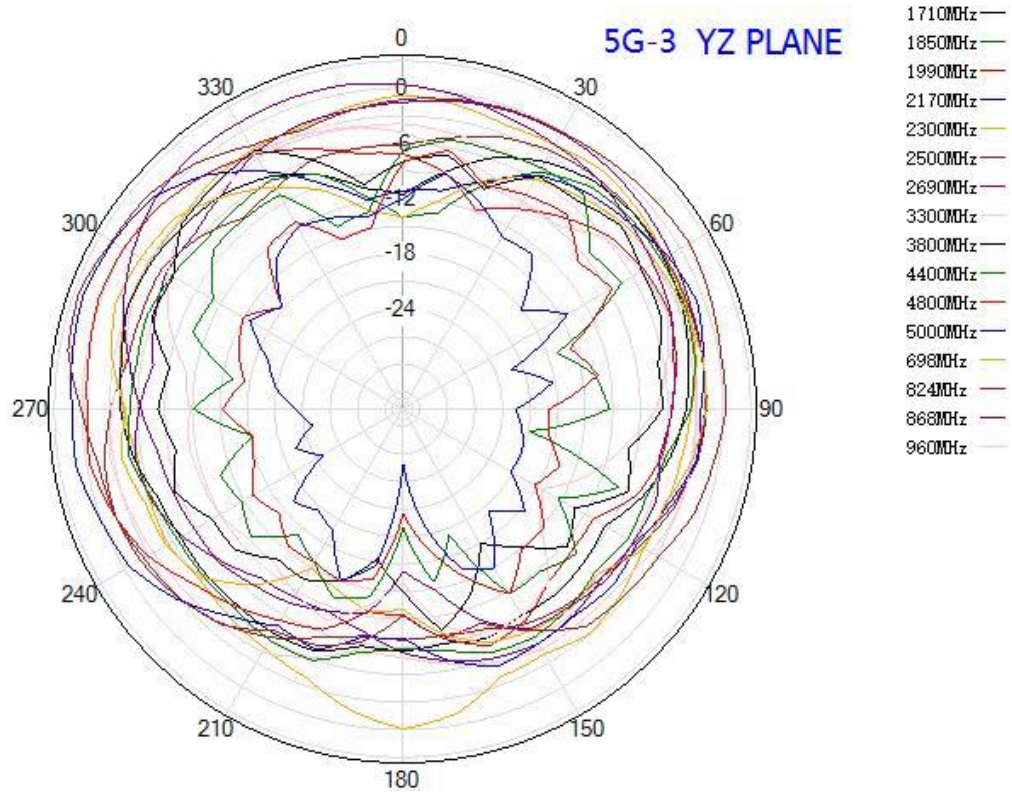

◆ Radiation Pattern(5G NR)

